

Executives

dvo_

dvo_



Lifeful place for lifeful people

Dal lavoro ibrido alla realtà in continua evoluzione: anche DVO si rinnova, rivelando una doppia anima. Un progetto nel progetto. Dal design dei servizi alla gestione completa di una commessa o di un intero progetto speciale.

Siamo una service company che risponde ad ogni idea creativa con prodotti sostenibili, un servizio just in time e una logistica affidabile, ma siamo anche partner di progetto, innovativo e versatile per professionisti e mondo corporate, fornendo un supporto completo in ogni fase del processo. Mettiamo al centro il benessere delle persone, perché questa è la vera evoluzione dello spazio lavoro.

La nostra impronta green, per il pianeta e per le future generazioni, passa anche attraverso l'utilizzo di materie prime rinnovabili, investimento continuo in certificazioni aziendali e di prodotto, controllo della qualità delle materie prime e dell'aria. Oggi siamo una duplice identità pronta a riscrivere le regole con un nuovo modello di business.

From hybrid work to constantly evolving reality: DVO renews itself, revealing a dual soul. A project within a project. From service design to the complete management of the global order or special project.

We are a service company that responds to every creative idea with sustainable products, a just-in-time service and reliable logistics, but we are also an innovative and versatile project partner for professionals and companies, providing comprehensive support at every stage of the process. We put people's well-being at the centre, because this is the true evolution of the workspace.

Our green thinking, for the planet and for future generations, goes also through the use of renewable raw materials, continuous investment in company and product certifications, quality control of raw materials and air. Today we are a twofold identity ready to rewrite the rules with a new model of business.

Fluid design

Equilibrio | Essenza umana | Inclusività | Natura | Fluidità |
Movimento | Design flessibile | Diversità | Benessere assoluto |
Smart living | Talento interiore | Evoluzione

Lavoro agile, libertà di integrare vita e lavoro, equilibrio e talento interiore. Il nuovo ufficio abbraccia l'essenza umana, diventando uno spazio privo di confini, disegnato per il benessere assoluto. Il design flessibile spinge verso ambienti rilassanti, stimolando la creatività e riducendo lo stress.

L'innovazione digitale amplifica questo viaggio, consentendo la scelta del luogo e dell'orario di lavoro. La diversità diventa inclusività, una contaminazione culturale e un nomadismo positivo che arricchiscono le possibilità, disegnando strade verso nuove prospettive, luoghi e volti.

L'evoluzione dell'ufficio crea spazi ibridi in continuo movimento, plasmati per soddisfare le esigenze mutevoli e per incentivare il dialogo con gli altri. L'armonia e la rigenerazione emergono dal bilanciamento di un'esistenza consapevole: uno stile di vita intelligente che grazie alla tecnologia crea un equilibrio responsabile, una connessione e una fluidità positiva tra lavoro e natura.

Balance | Human essence | Inclusivity | Nature | Fluidity |
Movement | Flexible design | Diversity | Absolute well-being |
Smart living | Inner talent | Evolution

Agile working, freedom to integrate life and work, balance and inner talent. The new workplace embraces the human essence, becoming a boundless space designed for absolute well-being. The flexible design pushes towards relaxing environments, stimulating creativity and reducing stress.

Digital innovation amplifies this journey, allowing the choice of place and working time. Diversity becomes inclusivity, cultural contamination and positive nomadism enriching possibilities, drawing roads to new perspectives, places and faces.

The evolution of the office creates hybrid spaces in constant movement, shaped to meet changing needs and to encourage dialogue. Harmony and regeneration emerge from the balance of conscious living: a smart living to create a responsible balance, connections and positive fluidity between work and nature.

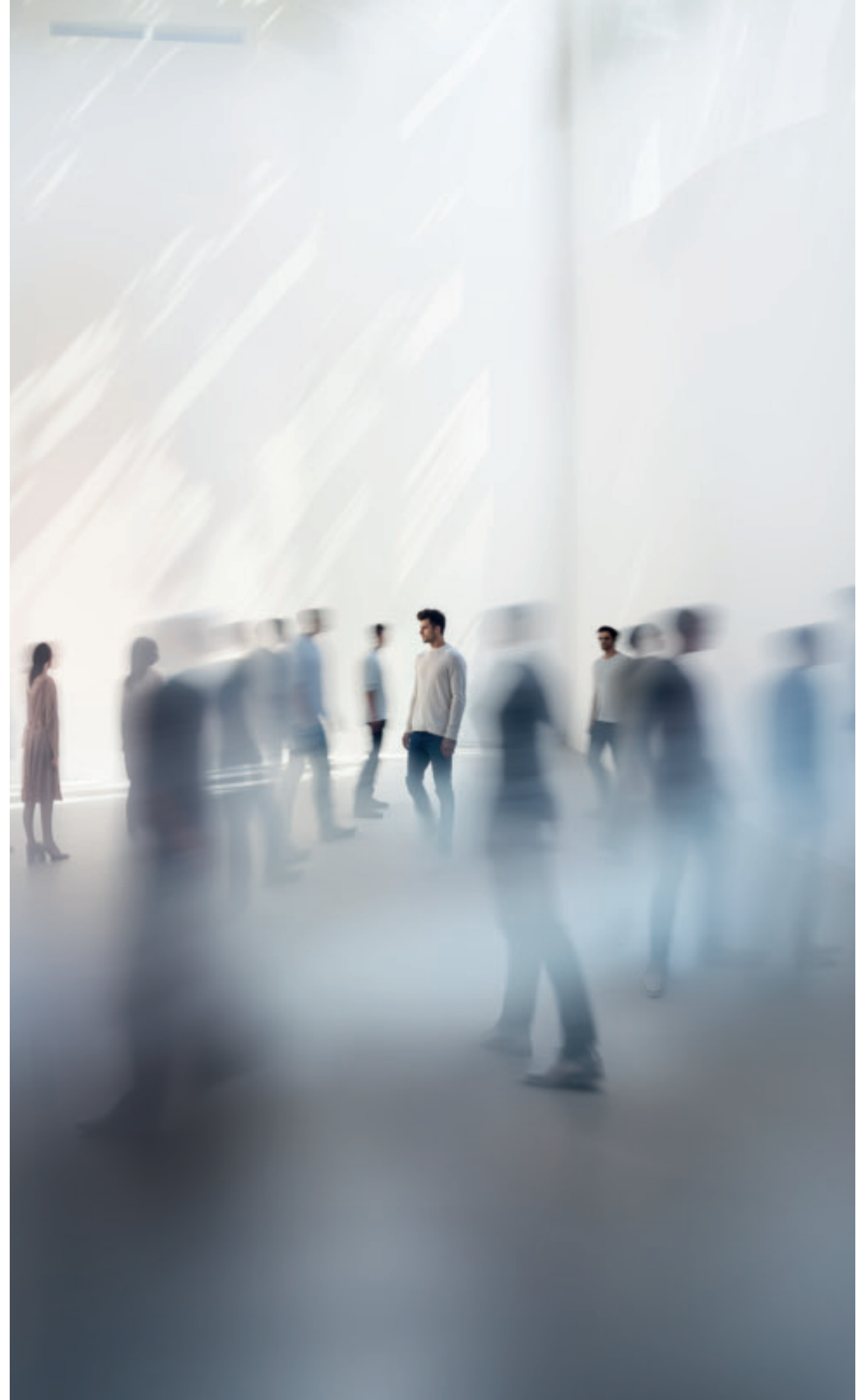



Rocks Executives

Archetipo di solidità e resistenza, la roccia è l'elemento naturale perfetto per accompagnare il racconto del catalogo Executives. La sua presenza, statuaria e monolitica per definizione, innesca un dialogo con lo spazio circostante connotandone prestigio ed esclusività.

An archetype of solidity and resistance, the rock is the perfect natural element to accompany the narrative of the executives catalogue. Its presence, sculptural and monolithic by definition, triggers a dialogue with the surrounding space, characterising prestige and exclusivity.

Indice
Index

Executives	VIGO DV913	p. 10
	NOTO DV911	p. 38
	RYM DV905	p. 56
	VERTIGO DV901	p. 72
	PLANETA DV902	p. 92
	DAKAR DV914	p. 108
	OXFORD DV910	p. 128

Specifiche tecniche Technical Sheets		p. 156
---	--	--------



VIGO

DV913

DV913-Vigo è un sistema d'arredo direzionale concepito per conferire personalità allo spazio ufficio, un habitat professionale all'insegna della tecnologia e del comfort, flessibile e aperto agli spazi condivisi. Nella concezione di ufficio direzionale, la scrivania DV913-Vigo è un'opera d'architettura in scala ridotta, minuzioso elemento di design in cui gli importanti spessori e finiture materiche caratterizzano i piani di lavoro. Le strutture delle scrivanie mettono in evidenza la particolare composizione tra la gamba portante e il telaio in alluminio. Il contrasto scultoreo di pesi e di volumi identifica a pieno lo spirito che anima la collezione DV913-Vigo.

DV913-Vigo is an executive furniture system designed to give distinctive personality to the office space, a professional environment under the banner of technology and comfort, flexible and ideal for open spaces. In the executive office concept, the DV913-Vigo desk is a small-scale work of architecture, a minimalist design element where the significant thicknesses and material finishes characterize the worktops. The desk structures highlight the special design between the leg and the aluminum frame. The contrast between weights and volumes fully identifies the spirit that drives the DV913-Vigo collection.



Scrivania con penisola sx L 285 P 130 cm
Piano scrivania: melaminico rovere scuro sp. 50 mm
Gambe pannellate: melaminico nero opaco soft touch L 10 cm
Struttura: in estruso di alluminio verniciato antracite
Desk with 1h round extension W 285 D 130 cm
Worktop: th. 50 mm dark oak finish melamine
Panelled legs: matt black soft touch finish melamine W 10 cm
Frame: extruded aluminium painted anthracite



La struttura è composta da un profilo rettangolare in estruso di alluminio W 100 H 20 mm e una trave canalizzabile.

Executives
DV913 - VIGO

The structure is composed of a rectangular aluminum extruded profile W 100 H 20 mm and a channelized beam.

Executive chair: Of Course



La gamba pannellata è dotata di un vano verticale per il passaggio dei cavi, che può essere ispezionato tramite un carter amovibile.

The paneled leg has a vertical compartment for cable routing, which can be inspected via a removable cover.



Executives
DV913 - VIGO



Scrivania L 220 P 220 cm con allungo laterale sx a giorno
Piano scrivania lato visitatore: melaminico noce sp. 60 mm
Piano scrivania superiore lato operatore e piano allungo: in vetro
temprato serigrafato sp. 10 mm bianco, con superficie acidata
Struttura: in estruso di alluminio verniciato alluminio
Desk W 220 D 220 cm with left open lateral return
Visitor-side worktop: th. 60 mm walnut finish melamine
Upper worktop of operator side and lateral return: th. 10 mm
white screen-printed tempered glass with etched surface
Frame: extruded aluminium painted aluminium





Il top-access è rivestito nella stessa finitura del piano scrivania
in melaminico oppure in vetro serigrafato (bianco o nero).
The top-access is available in the same finish as the melamine
Desktop or in screen-printed glass (white or black).

Executives
DV913 - VIGO



Tavolo riunioni L 240 P 120 cm
Piano: melaminico noce sp. 50 mm
Struttura: in estruso di alluminio verniciato alluminio
Meeting table W 240 D 120 cm
Top: th. 50 mm walnut finish melamine
Frame: extruded aluminium painted aluminium

Libreria con ante a ribalta L 215 H 158 P 45 cm
Scocca: melaminico noce sp. 50 mm
Schiena e ante: melaminico noce sp. 18 mm
Bookcase with folding doors W 215 H 158 D 45 cm
Structure: th. 50 mm walnut finish melamine
Backpanel and doors: th. 18 mm walnut finish melamine

Executives
DV913 - VIGO



Le ante a ribalta sono dotate di cerniere metalliche e meccanismo di apertura con sistema di regolazione. Sistema di apertura push-pull con blocco magnetico.

The folding doors are equipped with metal hinges and opening mechanism with adjustment system. Push-pull opening system with magnetic lock.



Scrivania L 220 P 220 cm con allungo dx
Piano scrivania: melaminico sp. 50 mm rovere chiaro
Struttura: in estruso di alluminio verniciato bianco
Desk W 220 D 220 cm with right lateral extension
Worktop: th. 50 mm Light oak finish melamine
Frame: extruded aluminium painted white

Executives
DV913 - VIGO





Tavolo riunioni - Ø 140 cm
Piano: melaminico sp. 50 mm rovere chiaro
Struttura: in estruso di alluminio verniciato bianco
Meeting table - Ø 140 cm
Top: th. 50 mm light oak finish melamine
Frame: extruded aluminium painted white

Executives
DV913 - VIGO

Executive chair: Of Course



Scrivania L 285 P 220 cm con allungo laterale sx e penisola dx
Piano scrivania lato visitatore: melaminico noce sp. 60 mm
Piano scrivania superiore lato operatore e piano allungo:
in vetro temprato serigrafato sp. 10 mm nero, con superficie acidata
Struttura: in estruso di alluminio verniciato antracite
Desk W 285 D 220 cm with left lateral return and right round extension
Visitor-side worktop: th. 60 mm walnut finish melamine
Upper worktop of operator side and lateral return:
th. 10 mm black screen-printed tempered glass with etched surface
Frame: extruded aluminium painted anthracite





Cassettiera per allungo a giorno
Cassetti in melaminico rivestiti in PVC grigio chiaro
dotati di guide metalliche telescopiche ad estrazione totale con sistema push-pull.
Il cassetto può essere integrato di telaio portacartelle

Pedestal for open lateral return
Light grey PVC-coated melamine drawers
equipped with full-extension telescopic metal glides with push-pull system.
Drawer can be integrated with file frame



Tavolo riunioni L 240 P 120 cm
Piano: melaminico sp. 50 mm noce
Struttura: in estruso di alluminio verniciato antracite
Meeting table W 240 D 120 cm
Top: th. 50 mm walnut finish melamine
Frame: extruded aluminium painted anthracite



Libreria con ante a ribalta L 215 H 158 P 45 cm
Scocca: melaminico sp. 50 mm noce
Schiena e ante: melaminico sp. 18 mm nero opaco soft touch
Bookcase with folding doors W 215 H 158 D 45 cm
Structure: th. 50 mm Walnut finish melamine
Back and doors: th. 18 mm matt black soft touch finish melamine

Executives
DV913 - VIGO





Design
ENZO BERTI

NOTO

DV911

L'idea di ambiente direzionale esce dai confini convenzionali dell'ufficio: non è più solo uno spazio lavorativo ma diventa un elegante palcoscenico in cui descrivere strategie di successo. La collezione DV911-Noto riprende l'idea del classico tavolo da lavoro su cavalletto. Tutto è realizzato con materiali naturali, vetro e legno, rivisitati per adattarsi sia allo spazio ufficio che in un elegante ambiente domestico. La struttura è in legno massello, noce canaletto o frassino verniciato antracite, mentre il piano è in vetro per uno stile leggero e minimale. La scrivania DV911-Noto è disponibile sia nella versione con piano rettangolare che semi-circolare. Un tavolo versatile dunque, le cui linee curve e spessori riprendono il meglio dell'artigianalità e ne preservano la contemporaneità.

The idea of the executive environment moves beyond the conventional boundaries of the office: it is no longer just a workspace but becomes an elegant stage on which to describe successful strategies. The DV911-Noto collection takes up the idea of the classic trestle work table. Everything is made of natural materials, glass and wood, revisited to fit both the office space and an elegant home environment. The frame is made of solid wood, "canaletto" walnut or anthracite painted ash, while the top is made of glass for a light and minimal style. The DV911-Noto desk top is available both with rectangular and with semi-circular shape. A versatile table whose curved lines and thicknesses take the best of craftsmanship and preserve its contemporary feel.



Scrivania L 200 P 100 cm
Piano scrivania: vetro temprato sp. 12 mm,
con bordi perimetrali lavorati a filo lucido. Finitura fumé
Gambe e travi: realizzate in legno massello
noce canaletto verniciato trasparente
Desk W 200 D 100 cm
Worktop: th. 12 mm tempered glass worktop
with outer polished edges. Smocked grey finish
Legs and beams: made of solid wood
walnut canaletto varnished transparent



Il traverso della gamba è impreziosito da 2 coperture in acciaio satinato fissate con calamite.
The leg beam is enriched with 2 satin-finished steel covers fixed with magnets.

Executives
DV911 - NOTO

Executive chair: Why Not



Tavolo riunioni L 240 P 120 cm
Piano: vetro temprato sp. 12 mm, con bordi perimetrali lavorati a filo lucido. Finitura fumé
Gambe e travi: realizzate in legno massello noce canaletto verniciato trasparente
Meeting table W 240 D 120 cm
Top: 12 mm tempered glass worktop with outer polished edges. Smocked grey finish
Legs and beams: made of solid wood, canaletto walnut finish, transparently varnished



I piani sono dotati di ghiera in zama incollate al piano.
Il fissaggio del piano alle travi ed alla gamba avviene mediante viti.
The tops are fitted with zamak rings glued to the top.
The top is fastened to the beams and the leg by means of screws.

Executives
DV911 - NOTO



Tavolo riunioni - Ø 140 cm
Piano: vetro temprato sp. 12 mm, con bordi perimetrali lavorati a filo lucido. Finitura fumé
Gambe e travi: realizzate in frassino verniciato antracite a poro aperto
Meeting table - Ø 140 cm
Top: 12 mm tempered glass worktop with outer polished edges. Smoked grey finish
Legs and beams: made of anthracite open-pore varnished ash wood

Contenitori di servizio, madie e pensili DV504-Milo
Strutture: melaminico grafite soft touch
Ante: melaminico verde opaco soft touch
Service cabinets, cabinets and wall units DV504-Milo
Structures: graphite soft touch finish melamine
Doors: matt green soft touch finish melamine

Executives
DV911 - NOTO



Scrivania L 200 P 100 cm
Piano scrivania: vetro temprato sp. 12 mm,
con bordi perimetrali lavorati a filo lucido. Finitura fumé
Gambe e travi: realizzate in frassino verniciato antracite a poro aperto
Mobile di servizio DV504-Milo

Desk W 200 D 100 cm
Worktop: 12 mm tempered glass worktop
with outer polished edges. Smocked grey finish
Legs and beams: made of anthracite open-pore varnished ash wood
Service cabinet DV504-Milo





Scrivania L 178 P 149 cm
Piano scrivania: vetro temprato sp. 12 mm, con bordi perimetrali lavorati a filo lucido. Finitura trasparente
Gambe e travi: realizzate in legno massello noce canaletto verniciato trasparente
Mobile di servizio DV504-Milo
Desk W 178 D 149 cm
Worktop: 12 mm tempered glass worktop with outer polished edges. Transparent finish
Legs and beams: made of solid wood, canaletto walnut finish, transparently varnished
Service cabinet DV504-Milo



Executive chair: Why Not

Executives
DV911 - NOTO



Tavolo riunioni L 240 P 120 cm
Piano: vetro temprato sp. 12 mm,
con bordi perimetrali lavorati a filo lucido. Finitura trasparente
Gambe e travi: realizzate in legno massello noce canaletto verniciato trasparente
Meeting table W 240 D 120 cm
Top: 12 mm tempered glass worktop with outer polished edges. Transparent finish
Legs and beams: made of solid wood, canaletto walnut finish, transparently varnished



Gamba in legno massello a sezione rotonda diam. 63 mm
Round solid wood leg diam. 63 mm

Executives
DV911 - NOTO





Design
ANTONIO MORELLO

RYM

DV905

Il tavolo DV905-Rym rappresenta la perfetta combinazione tra design minimalista e innovazione tecnologica, unendo eleganza e funzionalità. Le ampie superfici, lo stile essenziale e la cura dei dettagli esprimono l'anima di questa collezione.

La struttura in estruso di alluminio, apparentemente sottile ma resistente, si adatta a diversi ambienti e stili di arredamento garantendo una stabilità impeccabile.

La tecnologia "nascosta" all'interno del piano consente di ottenere tavoli di grandi dimensioni senza l'impiego di elementi strutturali intermedi garantendo pulizia formale e leggerezza.

Il piano di spessore 50 mm, è composto da un telaio perimetrale esterno e rinforzato da un telaio perimetrale interno. Il tavolo DV905-Rym è disponibile in diverse misure e colori per soddisfare le diverse esigenze progettuali.

The DV905-Rym table represents the union of minimalist design and technological innovation, combining elegance and functionality.

The large surfaces, essential style and attention to detail express the soul of this collection.

The minimal but strong aluminum structure adapts to different environments and furnishing styles, ensuring impeccable stability.

The "hidden" technology inside the top makes it possible to produce large dimensions tables without the use of intermediate structural elements ensuring a light look.

The 50 mm thick top is composed of an outer perimeter frame reinforced by an inner perimeter frame. The DV905-Rym table is available in different sizes and colours to meet the different design requirements.

Scrivania L 220 P 100 cm con allungo dx L 120 P 60 cm
Piano scrivania: realizzato con pannello ligneo sp. 50 mm
rivestito in laminato rovere scuro sp. 0.5 mm
Struttura: in alluminio finitura brill

Desk W 220 D 100 cm with right lateral return W 120 D 60 cm
Worktop: made of 50 mm thick wooden panel coated
with 0.5 mm thick dark oak laminate
Structure: "brill" polished aluminium



Profilo perimetrale in alluminio estruso disponibile in finitura bianco, alluminio brill o antracite
Extruded aluminum perimeter profile available in white, brill aluminum or anthracite finish

Executives
DV905 - RYM





Tavolo riunioni L 300 P 120 cm
Piano: realizzato con pannello ligneo sp. 50 mm
rivestito in laminatino bianco sp. 0.5 mm
Struttura: in alluminio finitura bianco
Meeting table W 300 D 120 cm
Top: made th. 50 mm wooden panel coated
with th. 0.5 mm white laminate
Structure: white finish aluminum



Scrivania L 220 P 100 cm
Piano scrivania: realizzato con pannello ligneo
sp. 50 mm rivestito in laminatino bianco sp. 0.5 mm
Struttura: in alluminio finitura bianco

Executives
DV905 - RYM

Meeting table W 220 D 100 cm
Worktop: made of th. 50 mm wooden panel
coated with th. 0.5 mm white laminate
Structure: white finish aluminum

Executive chair: Vega



Tavolo riunioni L 160 P 160 cm
Piano: realizzato con pannello ligneo sp. 50 mm
rivestito in laminatino rovere chiaro sp. 0.5 mm
Struttura: in alluminio finitura bianco
Meeting table W 160 D 160 cm
Top: made of th. 50 mm wooden panel coated
with th. 0.5 mm light oak laminate
Structure: white finish aluminum

Executive chair: Vega



Scrivania L 220 P 100 cm
Piano scrivania: realizzato con pannello ligneo sp. 50 mm
rivestito in laminato rovere chiaro sp. 0.5 mm
Struttura: in alluminio finitura bianco
Mobile di servizio: melaminico bianco

Desk W 220 D 100 cm
Worktop: made of th. 50 mm wooden panel coated
with th. 0.5 mm light oak laminate
Structure: white finish aluminum
Service cabinet: white finish melamine

Executives
DV905 - RYM



In opzione: canalina verticale in metallo per passaggio cavi.
Optional: vertical metal cable duct.

Executives
DV905 - RYM



Tavolo riunioni L 400 P 120 cm
Piano: realizzato con pannello ligneo sp. 50 mm rivestito
in laminatino nero sp. 0.5 mm
Struttura: in alluminio finitura nero
Meeting table W 400 D 120 cm
Top: made of th. 50 mm wooden panel coated
with th. 0.5 mm black laminate
Structure: black finish aluminum

Executives
DV905 - RYM



Design
ANTONIO MORELLO

VERTIGO

DV901

Le scrivanie DV901-Vertigo superano l'idea di scrivania tradizionale e rispondono ad un nuovo approccio di ambiente rappresentativo e funzionale. DV901-Vertigo è un tavolo caratterizzato da una solida struttura in pressofusione di alluminio a sezione trapezoidale e dall'originale design del giunto in pressofusione di zama che unisce, con equilibrio, il linguaggio tecnico-industriale a quello decorativo, dando vita ad un prodotto modulare e funzionale. Le gambe sono disponibili in due diverse tipologie: con base o senza base. Una collezione che possiede un forte grado di comfort e qualità estetica, spaziando dall'ambiente direzionale sino all'area operativa.

DV901-Vertigo desks go beyond the idea of the traditional desk and respond to a new approach of a representative and functional environment. DV901-Vertigo is a table characterized by a die-cast aluminium frame with a trapezoidal cross-section and by the original design of the zamak die-cast joint that combines a technical-industrial and decorative language, creating a modular, functional product. There are two different types of legs: with base or without base. This collection has a great degree of comfort and aesthetic quality, suitable for the executive environment as well as the operative areas.



Tavolo riunioni L 320 P 160 cm
Piano: melaminico verde opaco soft touch
Gambe: metallo verniciato verde opaco
Meeting table W 320 D 160 cm
Top: matt green soft touch finish melamine
Legs: matt green painted metal

Executives
DV901 - VERTIGO

Executive chair: Vega





Scrivania L 200 P 90 con allungo L 120 P 60 cm
Piano scrivania e modesty panel: melaminico rovere scuro
Gambe: in alluminio verniciato tortora

Desk W 200 D 90 with return W 120 D 60 cm
Worktop and modesty panel: dark oak finish melamine
Legs: painted taupe-coloured aluminium



La gamba è realizzata con montanti in estruso di alluminio di sezione triangolare 75x75 mm.
The leg is made of extruded aluminium uprights with a 75x75 mm triangular cross-section.

Executives
DV901 - VERTIGO





Scrivania L 200 P 90
Piano scrivania e modesty panel: melaminico bianco
Gambe: in alluminio verniciato
Desk W 200 D 90
Worktop and modesty panel: white finish melamine
Legs: in painted aluminium



Giunti angolari di collegamento e piedini fissi realizzati
in pressofusione di zama, cromati oppure verniciati.

Connecting corner joints and fixed feet made
of die-cast zamak, chrome-plated or painted.

Executives
DV901 - VERTIGO



Tavolo riunioni L 280 P 140 cm
Piano: melaminico bianco soft touch
Gambe: in alluminio verniciato bianco
Meeting table W 280 D 140 cm
Top: matt white soft touch finish melamine
Legs: painted white-coloured aluminium

Executives
DV901 - VERTIGO

Executive chair: Vega



Tavolo riunioni modulare L 280 P 136.5 cm
Piano: melaminico bianco
Gambe: massello impiallacciato in rovere naturale - metallo verniciato bianco
Modular meeting table W 280 D 136.5 cm
Top: white finish melamine
Legs: solid wood veneered with natural oak - white painted metal

Executives
DV901 - VERTIGO



Scrivania L 200 P 90 cm
Piano scrivania: melaminico noce
Gambe: in alluminio verniciato bianco
Mobile di servizio: melaminico bianco
Desk W 200 D 90 cm
Worktop: walnut finish melamine
Legs: painted white-coloured aluminium
Service cabinet: white finish melamine



Scrivania L 160 P 160 cm
Piano scrivania: melaminico noce
Gambe: in alluminio verniciato bianco
Mobile di servizio: melaminico bianco
Desk W 160 D 160 cm
Worktop: walnut finish melamine
Legs: painted white-coloured aluminium
Service cabinet: white finish melamine

Executives
DV901 - VERTIGO

Executive chair: Vega





PLANETA

DV902

La collezione DV902-Planeta riflette l'evoluzione della scrivania manageriale. Una linea direzionale elegante e minimale che si distingue attraverso il mobile di servizio che funge da struttura portante al tavolo oltre che elemento di archiviazione.

Il piano di lavoro è compatto e solido con la struttura. Sotto il piano di lavoro è presente un telaio perimetrale realizzato con estrusi di alluminio a sezione trapezoidale. La gamba ad anello, quale segno distintivo dell'intera collezione, è costituita da una cornice rettangolare di acciaio e nella parte superiore esterna della gamba è applicato un carter in lamiera piegata che conferisce originalità estetica. La varietà delle finiture rendono DV902-Planeta una scelta versatile e perfetta per chi cerca una scrivania manageriale progettata per durare nel tempo.

The DV902-Planeta collection reflects the evolution of the managerial desk. An elegant and minimal executive line that is distinguished through the service cabinet that serves as a supporting structure to the desk as well as a storage element.

The table top is solid with the structure. Under the worktop there is a perimeter frame made from trapezoidal-section made from extruded aluminium. The ring leg, as the feature of the entire collection, consists of a rectangular steel frame and a folded metal carter applied to the upper outer part of the leg, giving it aesthetic originality. The variety of finishes makes DV902-Planeta a versatile and the perfect choice for those seeking a managerial desk designed to last.



Tavolo riunioni L 160 P 160 cm
Piano: melaminico grafite soft touch
Gambe: metallo verniciato tortora
Meeting table W 160 D 160 cm
Top: graphite soft touch finish melamine
Legs: taupe painted metal

Executive chair: Vega



Scrivania L 200 P 90 cm
Piano scrivania: melaminico grafite soft touch
Gambe: metallo verniciato tortora
Mobile di servizio: melaminico tortora soft touch
Desk W 200 D 90 cm
Worktop: graphite soft touch finish melamine
Legs: taupe painted metal
Service cabinet: taupe soft touch finish melamine

Executives
DV902 - PLANETA



Scrivania L 200 P 90 cm
Piano scrivania: melaminico rovere chiaro
Gambe: metallo verniciato bianco
Mobile di servizio: melaminico bianco
Ante scorrevoli: melaminico rovere chiaro
Desk W 200 D 90 cm
Worktop: light oak finish melamine
Legs: white painted metal
Service cabinet: white finish melamine
Sliding doors: light oak finish melamine

Executives
DV902 - PLANETA



Tavolo riunioni L 240 P 120 cm
Piano: melaminico rovere chiaro
Gambe: metallo verniciato bianco
Meeting table W 240 D 120 cm
Top: light oak finish melamine
Legs: white painted metal



Scrivania L 180 P 90 cm
Piano scrivania: melaminico bianco
Gambe: metallo verniciato bianco
Mobile di servizio: melaminico bianco
Desk W 180 D 90 cm
Worktop: white finish melamine
Legs: white painted metal
Service cabinet: white finish melamine



Executives
DV902 - PLANETA



Scrivania L 200 P 90 cm integrabile con il mobile di servizio
Piano scrivania: melaminico rovere scuro
Gambe pannellate: melaminico rovere scuro con profilo metallo verniciato grafite
Mobile di servizio: melaminico rovere scuro
Desk W 200 D 90 cm to be connected to the service cabinet
Worktop: dark oak finish melamine
Panelled legs: dark oak melamine with graphite painted metal frame
Service cabinet: dark oak finish melamine

A sinistra: contenitori DV504-Milo.
Left: DV504-Milo storage units.

Executives
DV902 - PLANETA



Executive chair: Vega



Il mobile di servizio consente l'accesso alla gestione dei cablaggi.
The service cabinet allows access to wiring management.

Executives
DV902 - PLANETA





Design
ANTONIO MORELLO

DAKAR

DV914

DV914-Dakar è una moderna scrivania direzionale, dal design aereo, che mira a trasformare lo spazio di lavoro in luogo inclusivo e di interazione. Le scrivanie e i tavoli riunione, abbinati a contenitori di servizio e penisole, consentono di creare spazi manageriali non convenzionali, giocando tra funzioni e cromie. Le forme morbide e affusolate delle gambe coniche identificano i tavoli dell'intera collezione, mentre il dinamismo compositivo e la versatilità cromatica caratterizzano i diversi elementi che possono essere liberamente combinati tra loro.

DV914-Dakar is a modern and light executive desk that aims to transform the workspace into an inclusive place of interaction. The desks and meeting tables, combined with service storage units and peninsula tops, make it possible to create unconventional managerial spaces. The conical shapes of the legs identify the tables of the collection, while the wide range of compositions and colors characterize the various elements which can be freely combined.



Scrivania L 200 P 100
Piano scrivania e modesty panel: melaminico grafite soft touch
Gambe: metallo verniciato in finitura cromo
Desk W 200 D 100
Worktop and modesty panel: graphite soft touch finish melamine
Legs: painted metal in chrome finish
Executive chair: Vega



Tavolo riunioni circolare Ø 120 cm
Piano: melaminico grafite soft touch sp. 25 mm
Gambe: metallo verniciato in finitura cromo
Round meeting table Ø 120 cm
Top: graphite soft touch finish melamine th. 25 mm
Legs: painted metal in chrome finish

Executives
DV914 - DAKAR





Tavolo riunioni L 240 P 120 cm
Piano: melaminico rovere scuro
Gambe: metallo verniciato antracite
Meeting table W 240 D 120 cm
Top: dark oak finish melamine
Legs: anthracite painted metal

Executive chair: Vega



Scrivania L 200 P 100 con allungo L 100 P 65 cm
Piano scrivania e modesty panel: melaminico rovere scuro
Gambe: metallo verniciato antracite
Desk W 200 D 100 with return W 100 D 65 cm
Worktop and modesty panel: dark oak finish melamine
Legs: anthracite painted metal

Executives
DV914 - DAKAR





Scrivania L 200 P 100 cm
Piano scrivania: melaminico tortora soft touch
Gambe: metallo verniciato bianco
Mobile di servizio DV504-Milo: melaminico tortora soft touch
Ante: melaminico bianco
Desk W 200 D 100 cm
Worktop: taupe soft touch finish melamine
Legs: white painted metal
Service cabinet DV504-Milo: taupe soft touch finish melamine
Doors: white finish melamine

Scrivania L 160 P 160 cm
Piano scrivania: melaminico tortora soft touch
Gambe: metallo verniciato bianco
Mobile di servizio DV504-Milo: melaminico bianco
Ante: melaminico tortora soft touch
Desk W 160 D 160 cm
Worktop: taupe soft touch finish melamine
Legs: white painted metal
Service cabinet DV504-Milo: white finish melamine
Doors: taupe soft touch finish melamine

Executives
DV914 - DAKAR



Scrivania L 200 P 100 cm
Piano scrivania: melaminico rovere naturale
Gambe: metallo verniciato bianco
Mobile di servizio DV504-Milo: melaminico rovere naturale
Ante: melaminico bianco
Desk W 200 D 100 cm
Worktop: natural oak finish melamine
Legs: white painted metal
Service cabinet DV504-Milo: natural oak finish melamine
Doors: white finish melamine



Tavolo riunioni L 160 P 160 cm
Piano: melaminico rovere naturale
Gambe: metallo verniciato bianco
Meeting table W 160 D 160 cm
Top: natural oak finish melamine
Legs: white painted metal

Executives
DV914 - DAKAR

Executive chair: Vega



Scrivania L 250 P 125 cm
Piano scrivania: melaminico noce
Gambe: metallo verniciato antracite
Mobile di servizio P 66 cm DV-914 Dakar: melaminico nero soft touch
Desk W 250 D 125 cm
Worktop: walnut finish melamine
Legs: anthracite painted metal
Service cabinet D 66 cm DV-914 Dakar: matt black soft touch finish melamine

Executives
DV914 - DAKAR



Mobile di servizio L 180 P 66 DV914-Dakar
Anta scorrevole: melaminico nero soft touch
Cassetteria (optional): melaminico noce
Service cabinet W 180 D 66 cm DV914-Dakar
Sliding door: matt black soft touch finish melamine
Pedestal (optional): walnut finish melamine

Executives
DV914 - DAKAR



OXFORD

DV910

DV910-Oxford è una collezione executive che nasce da un'approfondita ricerca sull'evoluzione del lavoro contemporaneo. Un elemento d'arredo che genera un'alternanza di pieni e vuoti, rivelando preziosi dettagli funzionali e sofisticati equilibri proporzionali. DV910-Oxford propone scrivanie ad altezza fissa e regolabili in altezza. Il piano principale è formato da elementi rettangolari che giocano con la matericità delle finiture e, per una pulizia formale, possono essere scorrevoli e nascondere il cablaggio. La scrivania può essere corredata di un piano penisola circolare studiato come "guest area". Completano la collezione i contenitori di servizio, i tavoli riunione e l'armadio multifunzione che si presta sia in ambiente ufficio che domestico. Tutti gli elementi sono caratterizzati dallo stesso segno estetico: elementari geometrie basate su linee e forme essenziali che si intersecano tra loro e creano un insieme di grande eleganza.

V910-Oxford is an executive collection born out from in-depth research into the evolution of contemporary work. A piece of furniture that generates an interplay of solids and voids, revealing precious functional details and sophisticated proportional balances. DV910-Oxford offers fixed-height and height-adjustable desks. The main top is formed by rectangular elements that play with the texture of the finishes and, can become sliding tops to hide the cables. The desk can be equipped with a round peninsula top designed for the "guests area". The collection is completed by service storage units, meeting tables and a multifunctional cabinet that is suitable for both office and home environments. All the elements are characterized by the same aesthetic sign: elementary geometries based on essential lines and shapes that intersect with each other and create a set of great elegance.



Scrivania con mobile di servizio L 230 P 210 cm
Piano scrivania operatore e modesty panel:
melaminico nocciola effetto "pelle"
Piano scrivania visitatore: melaminico bianco
Gambe pannellate: melaminico bianco
Desk with service cabinet W 230 D 210 cm
Operator worktop and modesty panel:
'leather' effect hazelnut finish melamine
Visitor side desktop: white finish melamine
Panelled legs: white finish melamine



Piano scrivania scorrevole per una perfetta gestione dei cavi.
Sliding worktop for a perfect cable management.

Executives
DV910 - OXFORD

Executive chair: Of Course



Mobile di servizio con anta scorrevole e serratura centralizzata;
cassetto in metallo con serratura (optional).
Service cabinet with sliding door and central lock;
metal drawer with lock (optional).



Sportello superiore apribile
Il mobile è fornito di un portaprese
fissato alla schiena interna.
Opening upper door
The service cabinet is equipped with a
socket holder fixed to the internal back panel.

Executives
DV910 - OXFORD



Tavolo riunioni L 240 P 120 cm
Piano: melaminico bianco sp. 38 mm
Gambe pannellate: melaminico bianco
Top access: optional
Meeting table W 240 D 120 cm
Top: white finish melamine th. 38 mm
Panelled legs: white finish melamine
Top access: optional

Il layout delle pareti in vetro è a solo scopo illustrativo.
The glass wall partition layout is for illustrative purposes only.

Executives
DV910 - OXFORD



Il layout delle pareti in vetro è a solo scopo illustrativo.
The glass wall partition layout is for illustrative purposes only.

Scrivania L 220 P 214 cm con mobile di servizio.
Regolazione elettrica in altezza a tre stadi (75÷141 cm)
Piano scrivania operatore e modesty panel:
melaminico cappuccino effetto "pelle"
Piano scrivania visitatore: melaminico noce
Gambe pannellate: melaminico noce
Sit stand desk W 220 D 214 cm with service cabinet.
Electric three-stage height adjustment (H 75÷141 cm)
Operator worktop and modesty panel:
'leather' effect cappuccino finish melamine
Visitor side desktop: walnut finish melamine
Panelled legs: walnut finish melamine

Executives
DV910 - OXFORD





Tavolo riunioni L 240 P 120 cm
Piano: melaminico sp. 38 mm noce
Gambe pannellate: melaminico noce
Top access: optional
Meeting table W 240 D 120 cm
Top: walnut finish melamine th. 38 mm
Panelled legs: walnut finish melamine
Top access: optional

Executives
DV910 - OXFORD



Scrivania L 220 P 90 cm. Regolazione elettrica in altezza a tre stadi (75÷141 cm)
Piano scrivania operatore e modesty panel: melaminico rovere naturale
Piano scrivania visitatore: melaminico bianco
Gamba pannellata ispezionabile: melaminico bianco
Sit stand desk W 220 D 90 cm. Electric three-stage height adjustment (H 75÷141 cm)
Operator worktop and modesty panel: natural oak finish melamine
Visitor side desktop: white finish melamine
Panel leg with an opening casing: white melamine



Tastierino per regolazione altezza piano con 4 memorie
Gamba pannellata ispezionabile: melaminico bianco.
Control pad with 4 memories for height adjustable worktop
Panel leg with an opening casing: white melamine.



Executives
DV910 - OXFORD

Scrivania L 224 P 90 cm - (Lunghezze disponibili L 184 - 204 - 224 cm)
Piano scrivania operatore e modesty panel: melaminico rovere naturale
Piano scrivania visitatore: melaminico bianco
Desk W 224 D 90 cm - (Available lengths W 184 - 204 - 224 cm)
Operator worktop and modesty panel: natural oak finish melamine
Visitor side desktop: white finish melamine

Executives
DV910 - OXFORD

Executive chair: Of Course





Contenitore multifunzione L 250 P 60 H 190 cm
cassettiera/schiena puntinabile/barra Led (optional)
Multi-purpose storage unit W 250 D 60 H 190 cm
Carrying pedestal/Pinnable back panel/Led spotlight bar (optionals)

Executives
DV910 - OXFORD





Scrivania L 200 P 90 cm con gamba rientrante
Piano scrivania operatore e modesty panel: melaminico rovere chiaro
Piano scrivania visitatore: melaminico rovere chiaro
Gamba pannellata: melaminico rovere chiaro
Desk W 200 D 90 cm with shorter leg than worktop
Operator worktop and modesty panel: light oak finish melamine
Visitor side desktop: light oak finish melamine
Panel leg: light oak finish melamine



Tavolo riunioni L 140 P 140 cm
Piano: melaminico sp. 38 mm rovere chiaro
Gambe pannellate: melaminico rovere chiaro
Top access: optional

Meeting table W 140 D 140 cm
Top: light oak finish melamine th. 38 mm
Panelled legs: light oak finish melamine
Top access: optional

Executive chair: Of Course



Executives
DV910 - OXFORD



Scrivania con mobile di servizio L 250 P 210 cm con penisola L 120 cm
Piano scrivania operatore e modesty panel: melaminico nocciola effetto "pelle"
Piano scrivania visitatore: melaminico rovere scuro
Gambe pannellate: melaminico rovere scuro
Desk with service cabinet W 250 D 210 cm with round extension W 120 cm
Operator worktop and modesty panel: 'leather' effect hazelnut finish melamine
Visitor side desktop: dark oak finish melamine
Panelled legs: dark oak finish melamine



Tavolini caffè L 60 P 60 H 45 cm e L 120 P 60 H 45 cm
melaminico rovere scuro
Coffee tables W 60 D 60 H 45 cm and W 120 D 60 H 45 cm
dark oak finish melamine

Executives
DV910 - OXFORD



Specifiche Tecniche Technical Sheets

Executives	VIGO DV913	p. 158
	NOTO DV911	p. 162
	RYM DV905	p. 166
	VERTIGO DV901	p. 170
	PLANETA DV902	p. 176
	DAKAR DV914	p. 182
	OXFORD DV910	p. 186
	MILO DV504	p. 192

Wire Management		p. 197
-----------------	--	--------

Plug&Play DV300		p. 204
--------------------	--	--------



DV913 - VIGO
lato operatore | scrivania con piano sp. 50 mm
operator side | desk with worktop th. 50 mm



DV913 - VIGO
lato visitatore | scrivania con piano sp. 60 mm
visitor side | desk with worktop th. 60 mm



DV913 - VIGO LIBRERIA
DV913 - VIGO BOOKSHELF

LEGENDA
LEGEND

M Melaminico
Melamine

MT Metallo
Metal

V Vetro
Glass

* Non in pronta consegna
* Not in prompt delivery

Finiture Finishes

Scrivania - Tavoli riunione Desk - Meeting tables

M Piani scrivania sp. 50 mm - Modesty panel sp. 30 mm
Worktops th. 50 mm - Modesty panel th. 30 mm



V Piani scrivania supplementari sp. 10 mm in vetro temprato serigrafato, con superficie acidata
Additional worktops th. 10 mm screen-printed tempered glass with etched surface

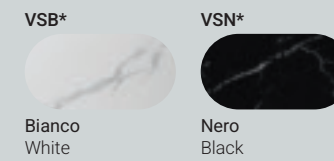

M Piani scrivania supplementari sp. 10 mm
Additional worktops th.10 mm



MT Strutture metalliche
Metal structures

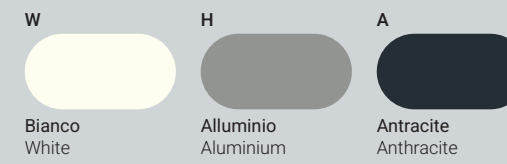

M Gambe pannellate sp. 100 mm - Pannelli sp. 18 mm uniti con tecnologia folding
Panelled legs th. 100 mm - panels th. 18 mm joined using folding technology



Libreria Bookshelf

M Scocche: Coperchio, fondo e ripiani sp.50 mm. Fianchi e divisori sp. 30 mm
Bodies: Top, bottom and shelves th. 50 mm. Side panels and divider panels th. 30 mm

Ante e schiene sp. 18 mm
Doors and back panels th. 18 mm

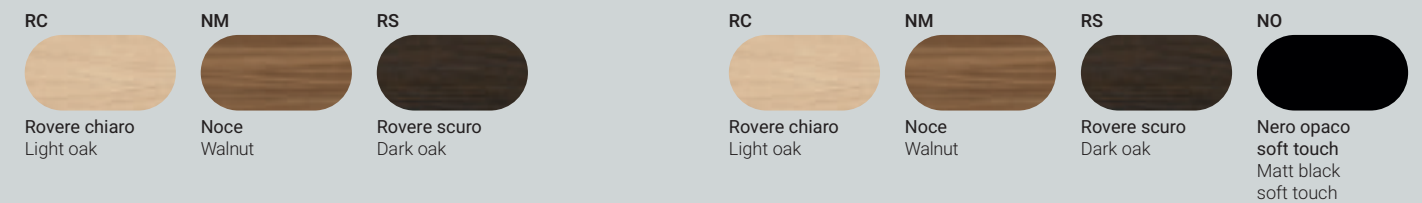

MT Strutture metalliche
Metal structures



Dati tecnici
Technical data

Scrivanie
Desks

Scrivanie con allungo a giorno
Desk with open extension

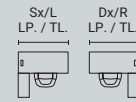
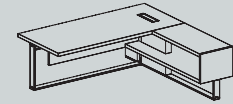

LP/TL 200 | L/W 200 | P/D 220 | H/H 75
220

Scrivanie con allungo
Desk with lateral extension

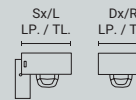
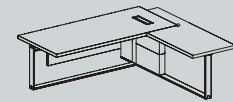

LP/TL 200 | L/W 230 | P/D 220 | H/H 75
220 250

Scrivanie con penisola
Desk with peninsula

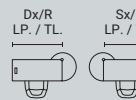
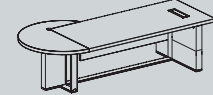

LP/TL 200 | L/W 265 | P/D 130 | H/H 75
220 285

V Scrivanie con piano e allungo a giorno in vetro
Desk with glass worktop and open lateral extension

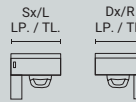
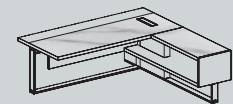

LP/TL 200 | L/W 200 | P/D 220 | H/H 76
220

V Scrivanie con piano e allungo laterale in vetro
Desk with glass worktop and lateral extension

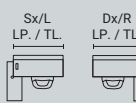
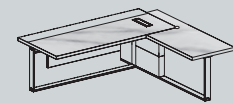

LP/TL 200 | L/W 230 | P/D 220 | H/H 76
220 250

V Scrivanie con piano e allungo laterale in vetro
Desk with glass worktop and lateral extension

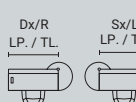
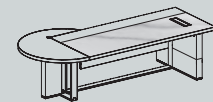

LP/TL 200 | L/W 265 | P/D 130 | H/H 76
220 285

Penisola
Peninsula



L/W 130 | P/D 130 | H/H 75

Penisola - per scrivania con piano in vetro
Peninsula - for desk with glass worktop

L/W 130 | P/D 130 | H/H 76

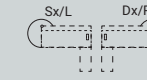
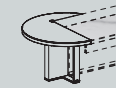

Cassetto per cassetiera - Optional
Drawer for pedestal - Optional

L/W 60 | P/D 50 | H/H 36.5

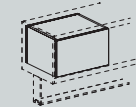

Cassetiera per allungo a giorno
Pedestal for open side extension

L/W 56 | P/D 41 | H/H 11

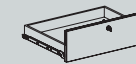

Reggicartella per cassetto
Folder frame for drawer

L/W 55 | P/D 40 | H/H 8



Tavoli riunione
Meeting tables

Tavolo riunioni - Ø 140
Meeting table - Ø 140

L/W 140 | P/D 140 | H/H 75



Tavolo riunioni - P 120
Meeting table - D 120

L/W 240 | P/D 120 | H/H 75

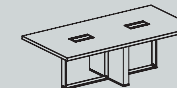

Libreria con ante a ribalta
Bookcase with flap doors

L/W 215 | P/D 45 | H/H 158

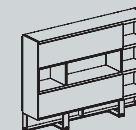

- M Melaminico
Melamine
- V Vetro
Glass

Dimensioni espresse in centimetri
Dimensions stated in centimetres



DV911 - NOTO

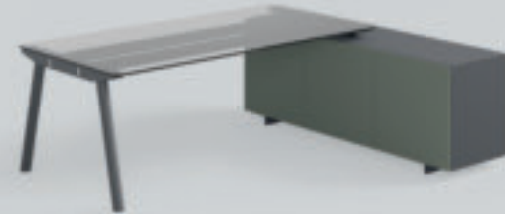

DV911 - NOTO
lato operatore
operator side

Finiture Finishes

Scrivania Desk

V Piani scrivania sp. 12 mm in vetro con bordi lucidi lavorati a filo
Glass worktops th. 12 mm with polished edges

VTR



Vetro trasparente
Transparent glass

VF



Vetro fumè
Smoked grey glass

M Modesty panel in melaminico sp. 18 mm
Melamine modesty panel th. 18 mm

WN

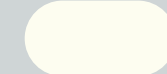

Bianco
White

NM



Noce
Walnut

NO*



Nero opaco
soft touch
Matt black
soft touch

W Gambe e travi in legno
Wooden legs and beams

ENC



legno massello
noce canaletto
verniciato
trasparente
solid wood of
Canaletto walnut,
transparent
painted

EAN



Frassino
verniciato
antracite
a poro aperto
open pore
anthracite -
coated
ash finish

LEGENDA LEGEND

M Melaminico
Melamine

W Legno
Wood

V Vetro
Glass

* Non in pronta consegna
* Not in prompt delivery

Per finiture e altri contenitori DV504 - Milo consultare pagine 192 - 193
See pages 192 - 193 for finishes and others DV504 - Milo storages

Dati tecnici
Technical data

Scrivania
Desk

Scrivanie P 60 - P 90 - P 100
D 60 - D 90 - D 100 desks

L/W	200	P/D	60	H/H	74
	180		90		
	200		100		



Integrabile su moduli base DV504-Milo
For integration with DV504-Milo base modules

L/W	200	P/D	60	H/H	74
	180		90		
	200		100		

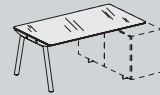

Modesty panel - Per scrivanie P 90-100
Modesty panels - For desks D 90-100

LP/TL	180	L/W	127	P/D	1.8	H/H	30
	200		147				



Modesty panel - Per tavolo semi-tondo P 149
Modesty panel - For semi-round table D 149

L/W	76	P/D	1.8	H/H	30
-----	----	-----	-----	-----	----

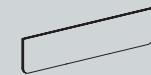

Tavoli riunione
Meeting tables

Tavolo riunioni - P 120
Meeting table - D 120

L/W	240	P/D	120	H/H	74
-----	-----	-----	-----	-----	----



Tavolo riunioni - Ø 140
Meeting table - Ø 140

L/W	140	P/D	140	H/H	74
-----	-----	-----	-----	-----	----



Tavolo riunioni - P 149
Meeting table - D 149

L/W	178	P/D	149	H/H	74
-----	-----	-----	-----	-----	----



Canalina passacavi verticale
Canale passacavi verticale

H/H	58
-----	----

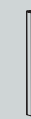

M Melaminico
Melamine

W Legno
Wood

V Vetro
Glass

Dimensioni espresse in centimetri
Dimensions stated in centimetres

Per finiture e altri contenitori DV504-Milo consultare pagine 192 - 193
See pages 192 - 193 for finishes and others DV504-Milo storages



DV905 - RYM



DV905 - RYM
lato operatore
operator side

Finiture Finishes

Scrivania Desk

- L** Piani scrivania sp. 50 mm realizzati con pannello ligneo e con rivestimento in laminatino sp. 0.5 mm
Worktops manufactured with th. 50 mm and wood panel with th 0.5 mm laminate coating

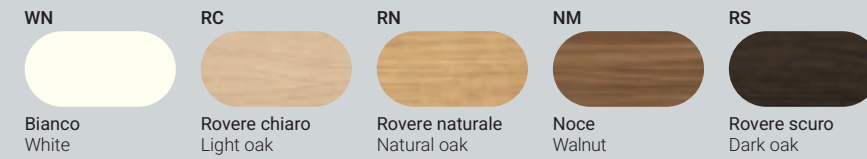

- F** Piani scrivania sp. 50 mm realizzati con pannello ligneo e con rivestimento in laminatino Fenix sp. 0.8 mm
Worktops manufactured with th. 50 mm and wood panel with Fenix coating with th. 0.8 mm Fenix coating

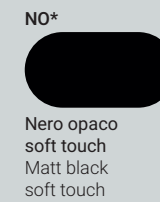

- V** Piani scrivania sp. 47 mm realizzati con pannello ligneo con applicata una lastra in vetro sp. 5 mm temprato retrolaccato con bordi perimetrali lavorati a filo lucido
Worktops manufactured with th. 47 mm wood panel on which a th. 5 mm rear-laquered tempered glass-plate, with outer polished edges, is applied



- V** Piani scrivania sp. 47 mm realizzati con pannello ligneo con applicata una lastra in vetro sp. 5 mm temprato retrolaccato acidato con bordi perimetrali lavorati a filo lucido
Worktops manufactured with th. 47 mm wood panel on which a th. 5 mm rear-laquered acetated tempered glass-plate, with outer polished edges, is applied

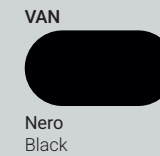

- M** Modesty panel sp. 18 mm
Modesty panel th. 18 mm



- MT** Strutture metalliche
Metal structures



LEGENDA LEGEND

M Melaminico
Melamine

F Fenix
Fenix

L Laminatino
Laminate

MT Metallo
Metal

* Non in pronta consegna
* Not in prompt delivery

Per finiture mobile di servizio consultare pag 180 - 181
See pages 180 - 181 for service unit finishes

Dati tecnici
Technical data

Scrivania
Desks

Scrivania P 90 - P 100
D 90 - D 100 desk



L/W 180	P/D 90	H/H 75
200	100	75
220		

Scrivania P 90 - P 100
D 90 - D 100 desk

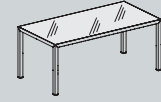

L/W 180	P/D 90	H/H 75
200	100	75
220		

Allungo
Desk return

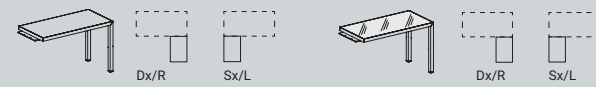

L/W 120	P/D 60	H/H 75	M
120	60	75	V

Scrivania P 100 integrabile con mobile di servizio
Desk D 100 to be connected to the service unit

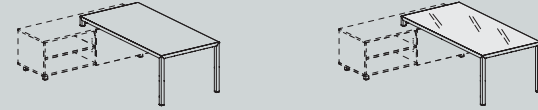

L/W 200	P/D 100	H/H 75	M
200	100	75	V
220			

Scrivania P 160 integrabile con mobile di servizio
Desk D 160 to be connected to the service unit

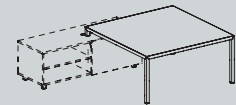

L/W 160	P/D 160	H/H 75
---------	---------	--------

Scrivania P 160 integrabile con mobile di servizio
Desk D 160 to be connected to the service unit

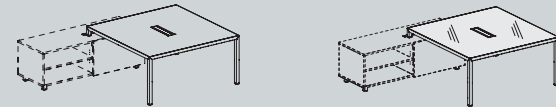

L/W 160	P/D 160	H/H 75	M
160	160	75	V

Mobile di servizio - P 66, P 92.5 - Indicare Dx o Sx
Service unit - D 66, D 92.5 - Specify R or L

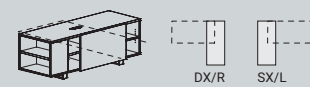

L/W 180	P/D 66	H/H 61
---------	--------	--------

Tavoli riunione
Meeting tables

Tavolo riunioni
Meeting table

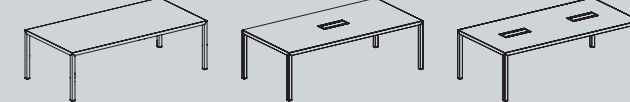

L/W 240	P/D 120	H/H 75
300		
400		

Tavolo riunioni
Meeting table

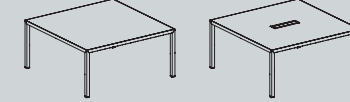

L/W 160	P/D 160	H/H 75
---------	---------	--------

Tavolo riunioni in vetro
Meeting table with glass

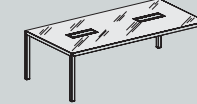

L/W 240	P/D 120	H/H 75
300		

Tavolo riunioni in vetro
Meeting table with glass

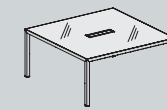

L/W 160	P/D 160	H/H 75
---------	---------	--------

M Melaminico
Melamine

V Vetro
Glass

Dimensioni espresse in centimetri
Dimensions stated in centimetres

Per finiture mobile di servizio consultare pag 180 - 181
See pages 180 - 181 for service unit finishes



DV901 - VERTIGO



DV901 - VERTIGO



DV901 - VERTIGO
lato operatore
operator side

Finiture Finishes

Scrivania Desk

M Piani scrivania sp. 18 mm e modesty panel sp. 18 mm
Worktops th. 18 mm and modesty panel th. 18 mm



M Solo per modesty panel sp. 18 mm
Only for modesty panel th. 18 mm

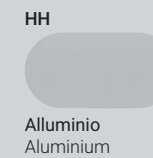

V Piani scrivania in vetro sp. 10 mm temperato retrolaccato
Rear-lacquered tempered glass worktops th. 10 mm



V Piani scrivania in vetro sp. 10 mm temperato retrolaccato. Acidato lato superiore
Rear-lacquered acetated tempered glass worktops th. 10 mm

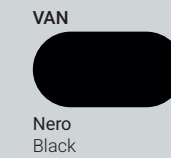

MT Strutture metalliche
Metal structures



MT Travi in metallo
Metal beams



LEGENDA LEGEND

M Melaminico
Melamine

MT Metallo
Metal

* Non in pronta consegna
* Not in prompt delivery

V Vetro
Glass

Per finiture mobile di servizio consultare pag 180 - 181
See pages 180 - 181 for service unit finishes

Dati tecnici
Technical data

Scrivania
Desks

Scrivania - Piano melaminico - P 80 - P 90
Desk - Melamine worktop - D 80 - D 90 desks

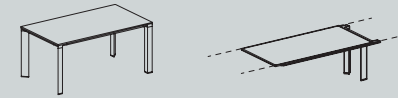

L/W	160 180 200	P/D	80 90 90	H/H	75
-----	-------------------	-----	----------------	-----	----

Scrivania - Piano melaminico - P 60
Desk - Melamine worktop - D 60



L/W	120	P/D	60	H/H	75
-----	-----	-----	----	-----	----

Allungo - Piano melaminico - P 60
Desk return - Melamine worktop - D 60

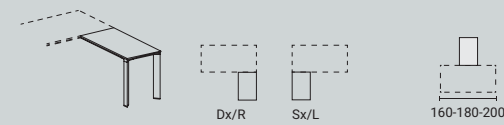

L/W	120	P/D	60	H/H	75
-----	-----	-----	----	-----	----

Scrivania - Gamba chiusa - P 90
Desk - Loop leg - D 90

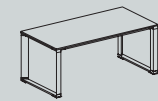

L/W	180 200	P/D	90	H/H	75
-----	------------	-----	----	-----	----

Scrivania - Gamba chiusa - Piano melaminico - P 60
Desk - Loop leg - Melamine worktop - D 60

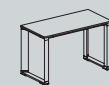

L/W	120	P/D	60	H/H	75
-----	-----	-----	----	-----	----

Allungo - Gamba chiusa - Piano melaminico - P 60
Desk return - Loop leg - Melamine worktop - D 60

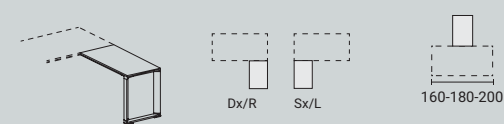

L/W	120	P/D	60	H/H	75
-----	-----	-----	----	-----	----

Scrivania in vetro - P 80 - P 90
Glass desk - D 80 - D 90



L/W	160 180 200	P/D	80 90 90	H/H	74.5
-----	-------------------	-----	----------------	-----	------

Scrivania in vetro - P 60
Glass desk - D 60

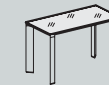

L/W	120	P/D	60	H/H	74.5
-----	-----	-----	----	-----	------

Allungo in vetro - P 60
Glass desk return - D 60

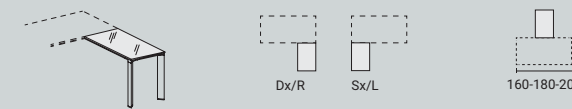

L/W	120	P/D	60	H/H	74.5
-----	-----	-----	----	-----	------

Scrivania in vetro - Gamba chiusa - P 90
Glass desk - Loop leg - D 90

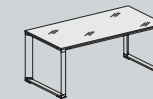

L/W	180 200	P/D	90	H/H	75
-----	------------	-----	----	-----	----

Scrivania in vetro - Gamba chiusa - P 60
Glass desk - Loop leg - D 60

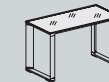

L/W	120	P/D	60	H/H	74.5
-----	-----	-----	----	-----	------

Allungo in vetro - Gamba chiusa - P 60
Glass desk return - Loop leg - D 60

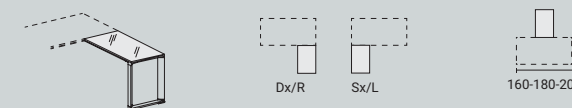

L/W	120	P/D	60	H/H	74.5
-----	-----	-----	----	-----	------

Dati tecnici
Technical data

Scrivania
Desks

Scrivania integrabile con mobile di servizio
Desk to be connected to the service unit



L/W	180 200	P/D	90	H/H	75	<input type="checkbox"/> M
	180 200		90		74.5	<input type="checkbox"/> V

Scrivania integrabile con mobile di servizio
Desk to be connected to the service unit



L/W	160	P/D	160	H/H	75	<input type="checkbox"/> M
	160		160		74.5	<input type="checkbox"/> V

Scrivania integrabile con mobile di servizio
Desk to be connected to the service unit

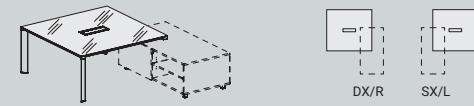

L/W	160	P/D	160	H/H	75	<input type="checkbox"/> M
	160		160		74.5	<input type="checkbox"/> V

Mobile di servizio - P 66, P 92.5 - Indicare Dx o Sx
Service unit - D 66, D 92.5 - Specify R or L

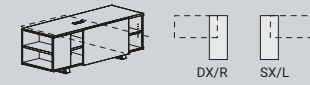

L/W	180	P/D	66	H/H	61
-----	-----	-----	----	-----	----

Modesty panel
Modesty panel

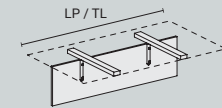

LP/TL	160	L/W	140	P/D	1.8	H/H	38
	180		160				
	200		180				

Modesty panel - Per tavolo L 180 - Con mobile di servizio
Modesty panel - For table W 180 - With service unit

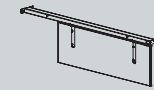

L/W	120	P/D	1.8	H/H	38
-----	-----	-----	-----	-----	----

Modesty panel - Per tavolo L 200 - Con mobile di servizio
Modesty panel - For desk W 200 - With service unit

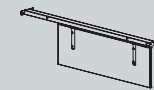

L/W	140	P/D	1.8	H/H	38
-----	-----	-----	-----	-----	----

Modesty panel - Per tavolo 160x160
Modesty panel - For table 160x160

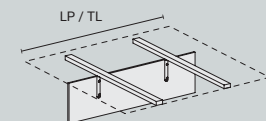

LP/TL	160	L/W	140	P/D	1.8	H/H	38
-------	-----	-----	-----	-----	-----	-----	----

Tavoli riunione
Meeting tables

Tavolo riunioni - P 100
Meeting table - D 100



L/W	100	P/D	100	H/H	75
-----	-----	-----	-----	-----	----

Tavolo riunioni - P 140 - P 160
Meeting table - D 140 - D 160

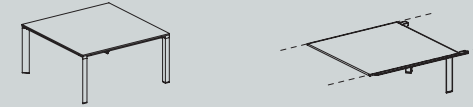

L/W	140 160	P/D	140 160	H/H	75
-----	------------	-----	------------	-----	----

Tavolo riunioni - P 120
Meeting table - D 120



L/W	240	P/D	120	H/H	75	<input type="checkbox"/> M
	240		120		74.5	<input type="checkbox"/> V

Tavolo riunioni in vetro - P 160
Meeting table with glass - D 160



L/W	160	P/D	160	H/H	74.5
-----	-----	-----	-----	-----	------

Tavolo riunioni in vetro
Meeting table with glass



L/W	100	P/D	100	H/H	74.5
-----	-----	-----	-----	-----	------



DV902 - PLANETA



DV902 - PLANETA

Finiture Finishes

Scrivania Desk

M Piani scrivania sp. 18 mm. Modesty panel sp. 18 mm. Gambe pannellate sp. 80 mm
Worktops th. 18 mm. Modesty panel th. 18 mm. Panelled legs th. 80 mm

RC



Rovere chiaro
Light oak

RN



Rovere naturale
Natural oak

NM



Noce
Walnut

RS



Rovere scuro
Dark oak

BN*

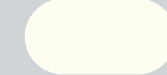

Bianco opaco
soft touch
Matt white
soft touch

TA*



Tortora
soft touch
Taupe
soft touch

VO*



Verde opaco
soft touch
Matt green
soft touch

GF*



Grafite
soft touch
Graphite
soft touch

NO*



Nero opaco
soft touch
Matt black
soft touch

M Solo per modesty panel sp. 18 mm
Only for modesty panel th. 18 mm

HH

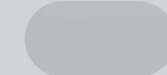

Alluminio
Aluminium

V Piani scrivania in vetro sp. 10 mm temperato retrolaccato
Rear-lacquered tempered glass worktops th. 10 mm

VW

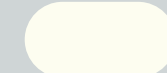

Bianco
White

V Piani scrivania in vetro sp. 10 mm temperato retrolaccato. Acidato lato superiore
Rear-lacquered acetated tempered glass worktops th. 10 mm

VAN



Nero
Black

MT Strutture metalliche
Metal structures

W

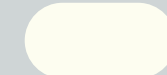

Bianco
White

H



Alluminio
Aluminium

A

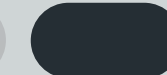

Antracite
Anthracite

TA*



Tortora
Taupe

VO*



Verde opaco
Matt green

GF*



Grafite
Graphite

N*



Nero
Black

MT Travi in metallo
Metal beams

HH



Alluminio
Aluminium

LEGENDA LEGEND

M Melaminico
Melamine

MT Metallo
Metal

V Vetro
Glass

* Non in pronta consegna
* Not in prompt delivery

Per finiture mobile di servizio consultare pag 180 - 181
See pages 180 - 181 for service unit finishes

Dati tecnici
Technical data

Scrivania
Desk

Scrivania P 90 - Piano melaminico
Desk D 90 - Melamine worktop

L/W 180 |
200 | P/D 90 | H/H 75 |

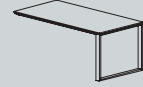

Scrivania P 90 - Piano melaminico - Gambe pannellate
Desk D 90 - Melamine worktop - Panelled legs

L/W 180 |
200 | P/D 90 | H/H 75 |

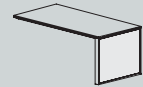

Scrivania P 90 - Piano in vetro
Desk D 90 - Glass worktop

L/W 180 |
200 | P/D 90 | H/H 75 |

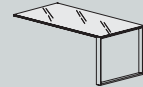

Scrivania P 90 - Piano in vetro - Gambe pannellate
Desk D 90 - Glass worktop - Panelled legs

L/W 180 |
200 | P/D 90 | H/H 75 |

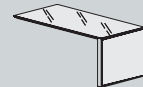

Mobile di servizio - P 66 - Indicare Dx o Sx
Service unit - D 66 - Specify R or L

L/W 180 | P/D 66 | H/H 61 |



Tavoli riunione
Meeting tables

Tavolo riunioni - P 100
Meeting table - D 100

L/W 100 | P/D 100 | H/H 75 |



Tavolo riunioni - P 140 - P 160
Meeting table - D 140 - D 160

L/W 140 |
160 | P/D 140 |
160 | H/H 75 |



Tavolo riunioni - P 120
Meeting table - D 120

L/W 240 | P/D 120 | H/H 75 | M
240 | 120 | 74.5 | V



Tavolo riunioni in vetro - P 160
Meeting table with glass - D 160

L/W 160 | P/D 160 | H/H 74.5 | M
160 | 160 | 74.5 | V

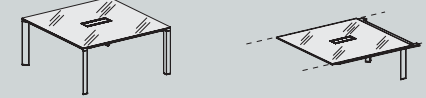

Tavolo riunioni in vetro
Meeting table with glass

L/W 100 | P/D 100 | H/H 74.5 |



M Melaminico
Melamine

MT Metallo
Metal

Dimensioni espresse in centimetri
Dimensions stated in centimetres

Per finiture mobile di servizio consultare pag 180 - 181
See pages 180 - 181 for service unit finishes

RYM | VERTIGO | PLANETA
DV905 | DV901 | DV902

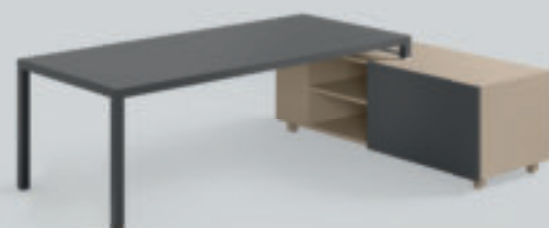

DV902 - RYM
lato operatore
operator side



DV901 - VERTIGO
lato operatore
operator side









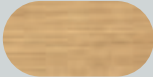

DV902 - PLANETA

Finiture Finishes

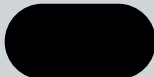
Mobile di servizio Service unit

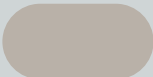
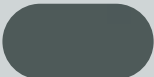

M Mobile di servizio P 66, sp. 18/25 mm, cassettera per vano interno, ripiano sp. 25 mm, in melaminico
Service unit D 66, th. 18/25, pedestal for inside service unit, shelf th. 25 mm, in melamine

WN  Bianco White	RC  Rovere chiaro Light oak	RN  Rovere naturale Natural oak	NM  Noce Walnut	RS  Rovere scuro Dark oak
NO  Nero opaco soft touch Matt black soft touch	BN*  Bianco opaco soft touch Matt white soft touch	TA*  Tortora soft touch Taupe soft touch	VO*  Verde opaco soft touch Matt green soft touch	GF*  Grafite soft touch Graphite soft touch

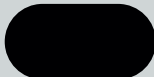
MT Top access in alluminio
Top access in aluminium

W  Bianco White	HN  Nero anodizzato Anodized black	HH  Alluminio anodizzato Anodized aluminium
--	---	--

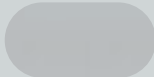
MT Strutture metalliche
Metal structures

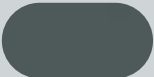
W  Bianco White	H  Alluminio Aluminium	A  Antracite Anthracite	TA*  Tortora Taupe	VO*  Verde opaco Matt green	GF*  Grafite Graphite	N*  Nero Black
--	---	--	---	--	--	---

LEGENDA LEGEND

M Melaminico
Melamine
MT Metallo
Metal

* Non in pronta consegna
* Not in prompt delivery



DV914 - DAKAR







DV914 - DAKAR
lato operatore
operator side

Finiture Finishes

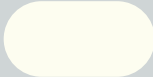
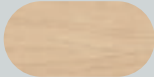
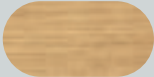
Scrivania - Tavoli riunione Desk - Meeting tables

M Piani scrivania sp. 25 mm e modesty panel sp. 18 mm
Worktops th. 25 mm and modesty panel th. 18 mm

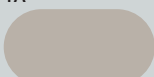
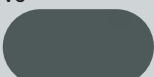
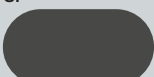
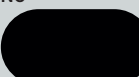
WN  Bianco White	RC  Rovere chiaro Light oak	RN  Rovere naturale Natural oak	NM  Noce Walnut	RS  Rovere scuro Dark oak
BN*  Bianco opaco soft touch Matt white soft touch	TA*  Tortora soft touch Taupe soft touch	VO*  Verde opaco soft touch Matt green soft touch	GF*  Grafite soft touch Graphite soft touch	NO*  Nero opaco soft touch Matt black soft touch

MT Strutture metalliche
Metal structures

W  Bianco White	X  Cromo Chrome	A  Antracite Anthracite
--	--	--

PE Puntale livellatore in polietilene
Polyethylene levelling feet

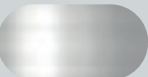





X  Cromo Chrome
--

MT Travi in metallo
Metal beams

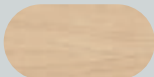
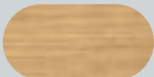
HH  Alluminio Aluminium
--

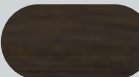
Mobile di servizio Service unit

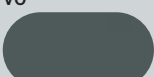
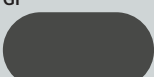
M Mobile di servizio P 66, sp. 18/25 mm, cassettera per vano interno, ripiano sp. 25 mm, in melaminico
Service unit D 66, th. 18/25, pedestal for inside service unit, shelf th. 25 mm, in melamine

WN  Bianco White	RC  Rovere chiaro Light oak	RN  Rovere naturale Natural oak	NM  Noce Walnut	RS  Rovere scuro Dark oak
BN*  Bianco opaco soft touch Matt white soft touch	TA*  Tortora soft touch Taupe soft touch	VO*  Verde opaco soft touch Matt green soft touch	GF*  Grafite soft touch Graphite soft touch	NO*  Nero opaco soft touch Matt black soft touch

LEGENDA LEGEND

M Melaminico
Melamine

PE Polietilene
Polyethylene

MT Metallo
Metal

* Non in pronta consegna
* Not in prompt delivery

Dati tecnici
Technical data

Scrivania
Desk

Scrivania P 80 - P 100 - P 120
D 80 - D 100 - D 120



L/W	180	P/D	80	H/H	75
	200		100		
	240		120		

Allungo
Desk return



L/W	100	P/D	65	H/H	75
-----	-----	-----	----	-----	----

Scrivania integrabile con mobile di servizio o moduli DV504-Milo
Desk to be connected to the service unit or base modules DV504-Milo

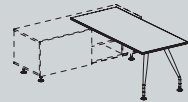

L/W	180	P/D	80	H/H	75
	200		100		

Scrivania con 3 gambe e 1 sostegno - Integrabile con mobile di servizio o moduli DV504-Milo
Desk with 3 legs and 1 support - To be connected to the service unit or DV504-Milo base modules

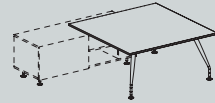

L/W	160	P/D	160	H/H	75
-----	-----	-----	-----	-----	----

Scrivania con 2 gambe e 2 sostegni - Integrabile SOLO con moduli DV504-Milo
Desk with 2 legs and 2 supports - To be connected ONLY with DV504-Milo base modules

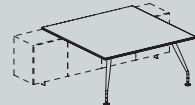

L/W	160	P/D	160	H/H	75
-----	-----	-----	-----	-----	----

Scrivania integrabile con mobile di servizio o moduli DV504-Milo
Desk to be connected to the service unit or base modules DV504-Milo

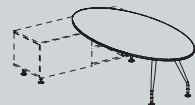

L/W	250	P/D	125	H/H	75
-----	-----	-----	-----	-----	----

Modesty panel in melaminico
Melamine modesty panel

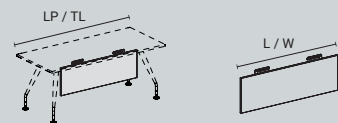

LP/TL	160	L/W	100	P/D	1.8	H/H	35
	180		120				
	200		140				
	250		140				

Modesty panel in melaminico - Per scrivania integrabile
Melamine modesty panel - For suspended desk



LP/TL	160	L/W	100	P/D	1.8	H/H	35
	180		100				
	200		120				
	250		120				

Mobile di servizio - P 66 - Indicare Dx o Sx
Service unit - D 66 - Specify R or L

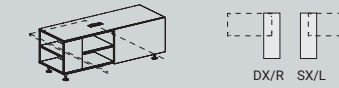

L/W	180	P/D	66	H/H	61
-----	-----	-----	----	-----	----

Tavoli riunione
Meeting tables

Tavolo riunioni - P 160
Meeting table - D 160



L/W	160	P/D	160	H/H	75
-----	-----	-----	-----	-----	----

Tavolo riunioni - P 125
Meeting table - D 125



L/W	250	P/D	125	H/H	75
-----	-----	-----	-----	-----	----

Tavolo riunioni - Ø 120
Meeting table - Ø 120



L/W	120	P/D	120	H/H	75
-----	-----	-----	-----	-----	----

Tavolo riunioni integrabile con mobile di servizio
Meeting table to be connected to the service unit

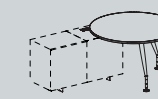

L/W	120	P/D	120	H/H	75
-----	-----	-----	-----	-----	----



DV910 - OXFORD



DV910 - OXFORD



DV910 - OXFORD
lato operatore
operator side

Finiture Finishes

Scrivania - Tavoli riunione Desk - Meeting tables

M Piano operatore sp. 38 mm - Modesty panel sp. 25 mm
User-side worktop th. 38 mm - Modesty panel th. 25 mm



M Piano visitatore
Visitor-side worktop

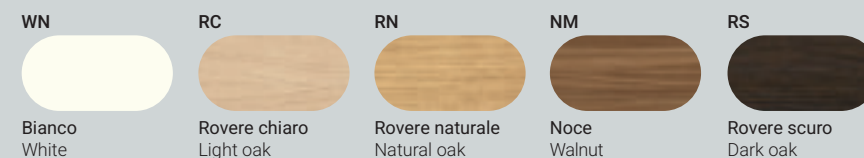

M Gambe pannellate sp. 38 mm
Pannelled legs th. 38 mm

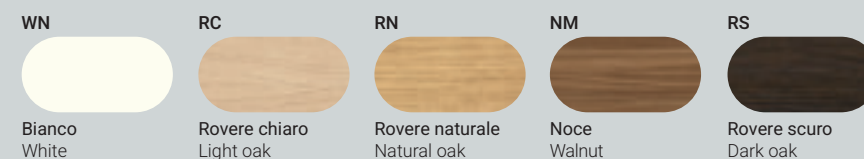

MT Colonne per regolazione in altezza da 64.5 a 130 cm
Columns for height adjustment from 64.5 to 130 cm



Mobile di servizio Service cabinet

M Scocca in melaminico sp. 25/38 mm - Ripiani in melaminico sp. 25 mm
Th. 25/38 mm melamine structure - th. 25 mm melamine shelves

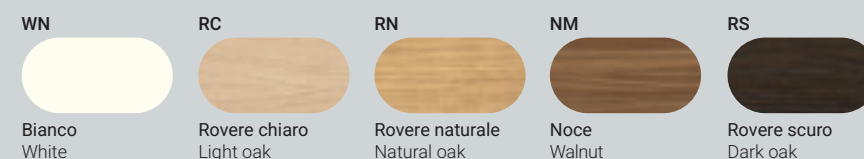

M Ante sp. 18 mm bordate in ABS
Th. 18 mm doors edged in ABS perimeter

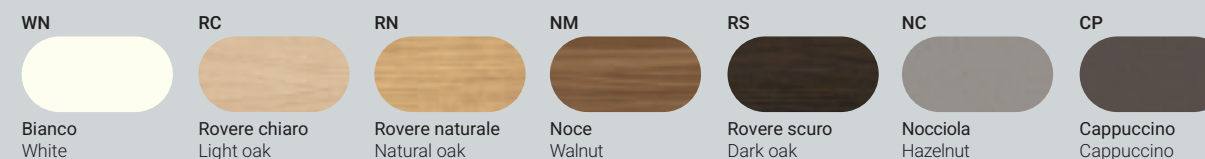

LEGENDA LEGEND

M Melaminico
Melamine

MT Metallo
Metal

T Tessuto
Fabric

* Non in pronta consegna
* Not in prompt delivery



DV910 - OXFORD

Finiture Finishes

Mobile multifunzione* Multifunctional cabinet*

M Scocche sp. 38 mm
Structure th. 38 mm

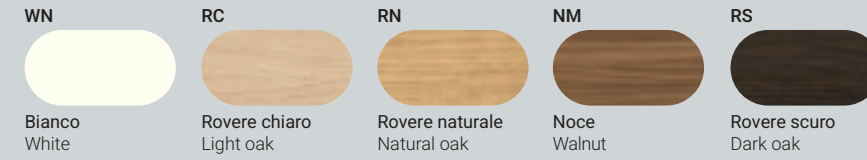

M Ante sp. 18 mm - Piani scrivania sp. 38 mm
Doors th. 18 mm - Worktops th. 38 mm

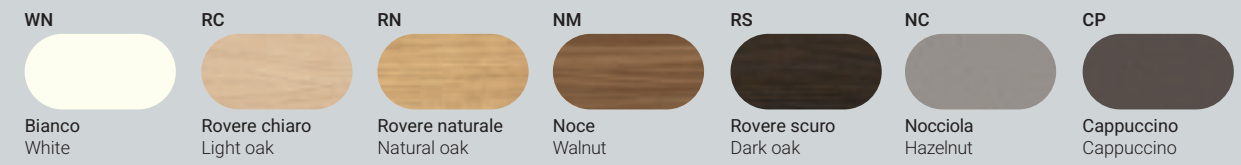

T Schiena puntinabile
Pinnable backpanel



LEGENDA LEGEND

M Melaminico
Melamine

T Tessuto
Fabric

* Non in pronta consegna
* Not in prompt delivery

Dati tecnici
Technical data

Scrivania
Desk

Scrivania - Piano melaminico - P 90
Desk - Melamine worktop - D 90

L/W	184 204 224	P/D	90	H/H	75
-----	-------------------	-----	----	-----	----

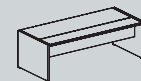

Scrivania - Indicare Dx o Sx
Desk - Specify R or L

L/W	180 200 220	P/D	90	H/H	75
-----	-------------------	-----	----	-----	----



Scrivania con allungo
Desk with extension

L/W	180 200 220	P/D	210	H/H	75
-----	-------------------	-----	-----	-----	----



Scrivania con mobile di servizio
Desk with service unit

LP/TL	180 200 220	L/W	210 230 250	P/D	210	H/H	75
-------	-------------------	-----	-------------------	-----	-----	-----	----

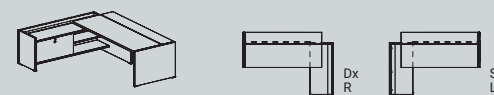

Scrivania con piano sliding e mobile di servizio
Desk with sliding tops and service unit

LP/TL	180 200 220	L/W	210 230 250	P/D	210	H/H	75
-------	-------------------	-----	-------------------	-----	-----	-----	----



Scrivania regolabile in altezza elettricamente
Desk with electric height adjustment

L/W	180 200 220	P/D	90	H/H	75+141
-----	-------------------	-----	----	-----	--------

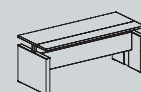

Scrivania regolabile in altezza elettricamente - Con mobile di servizio
Desk with electric height adjustment - With service unit

L/W	180 200 220	P/D	214	H/H	75+141
-----	-------------------	-----	-----	-----	--------

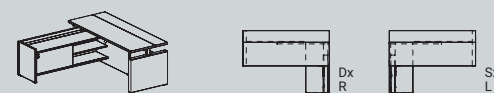

Penisola con gambe
End meeting element with leg

L/W	120	P/D	120	H/H	75
-----	-----	-----	-----	-----	----



Contenitore multifunzione
Multi-purpose storage unit

L/W	250	P/D	60	H/H	190
-----	-----	-----	----	-----	-----

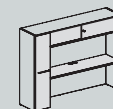

Composizione con scrivania e contenitore multifunzione
Composition with desk and multi-purpose storage unit

LP/TL	200 220	L/W	250	P/D	266	H/H	190
-------	------------	-----	-----	-----	-----	-----	-----

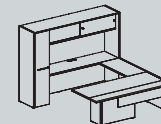

Tavoli riunione
Meeting table

Tavolo riunioni - P 140
Meeting table - D 140

L/W	140	P/D	140	H/H	75
-----	-----	-----	-----	-----	----

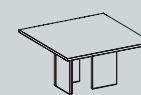

Tavolo riunioni - P 120
Meeting table - D120

L/W	240	P/D	120	H/H	75
-----	-----	-----	-----	-----	----

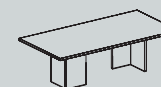

Tavolino caffè
Coffee table

L/W	60 120	P/D	60	H/H	45
-----	-----------	-----	----	-----	----

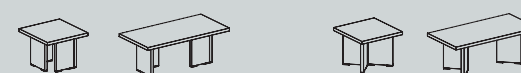



DV504 - MILO



DV504 - MILO



DV504 - MILO

Finiture Finishes

Contenitore Cabinet

M Scocche in Folding - melaminico sp. 18 mm
Folding structures - melamine th. 18 mm

WN	RN	NM	BN*	TA*	VO*	GF*	NO*
Bianco White	Rovere naturale Natural oak	Noce Walnut	Bianco opaco soft touch Matt white soft touch	Tortora soft touch Taupe soft touch	Verde opaco soft touch Matt green soft touch	Grafite soft touch Graphite soft touch	Nero opaco soft touch Matt black soft touch

M Ante / frontali / schiene in melaminico sp. 18 mm
Melamine doors / drawers fronts / backs th. 18 mm

WN	RC	RN	NM	RS	GQ	VM	TD
Bianco White	Rovere chiaro Light oak	Rovere naturale Natural oak	Noce Walnut	Rovere scuro Dark oak	Grigio chiaro Light grey	Verde marino Green marine	Terra d'ombra Umber
BN*	TA*	VO*	GF*	NO*	NC*	CP*	
Bianco opaco soft touch Matt white soft touch	Tortora soft touch Taupe soft touch	Verde opaco soft touch Matt green soft touch	Grafite soft touch Graphite soft touch	Nero opaco soft touch Matt black soft touch	Nocciola Hazelnut	Cappuccino Cappuccino	

M Moduli superiori in melaminico sp. 10 / 18 mm
Upper module in melamine th. 10 / 18 mm

WN	RN	NM	BN*	TA*	VO*	GF*	NO*
Bianco White	Rovere naturale Natural oak	Noce Walnut	Bianco opaco soft touch Matt white soft touch	Tortora soft touch Taupe soft touch	Verde opaco soft touch Matt green soft touch	Grafite soft touch Graphite soft touch	Nero opaco soft touch Matt black soft touch

MT Zoccoli metallici
Metal base frames

W	H	A	N	TA*	VO*	GF*
Bianco White	Alluminio Aluminium	Antracite Anthracite	Nero Black	Tortora Taupe	Verde opaco Matt green	Grafite Graphite

MT Barra metallica
Metal bar

W	H
Bianco White	Alluminio Aluminium

LEGENDA LEGEND

M Melaminico
Melamine

PE Polietilene
Polyethylene



MT Metallo
Metal

* Non in pronta consegna
* Not in prompt delivery



Dati tecnici
Technical data

Scrivania
Desk

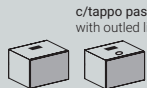

Modulo base L 60
Base module W 60

			L/W 60	P/D 50	H/H 40
					
con anta with door	con cassettoni with drawer	c/tappo passacavi with outled lid con vano tecnico per integrazione scrivanie with technical compartment for hanged desk			



Modulo base L 120
Base module W 120

		L/W 120	P/D 50	H/H 40
				
con 2 ante with 2 doors	con 2 cassettoni with 2 drawers			

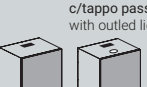
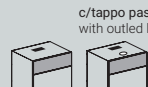
Modulo base L 60
Base module W 60

			L/W 60	P/D 50	H/H 60
					
con anta with door	con 2 cassetti with 2 drawers	con cassettoni with drawer	c/tappo passacavi with outled lid	Con vano tecnico With technical compartment	c/tappo passacavi with outled lid Con vano tecnico With technical compartment

Modulo base L 120
Base module W 120

		L/W 120	P/D 50	H/H 60
				
con 2 ante with 2 doors	con 2 cassettoni with 2 drawers			

Modulo base L 60
Base module W 60

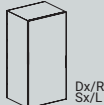
		L/W 60	P/D 50	H/H 120
				

Modulo superiore L 60
Upper module W 60

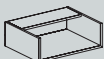
		L/W 60	P/D 48	H/H 20
				

Modulo superiore L 120 - A giorno
Upper module W 120 - Open

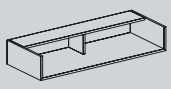
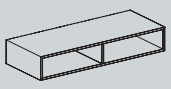
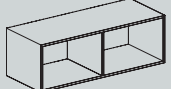
		L/W 120	P/D 48	H/H 20
		L/W 120	P/D 48	H/H 20
		120	48	40
				

MT Zoccolo metallico H 6.1
Metal plinth H 6.1

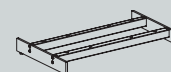

LP/TL 120	L/W 80	P/D 48	H/H 6,1
LP/TL 180	L/W 140	P/D 48	H/H 6,1
LP/TL 240	L/W 200	P/D 48	H/H 6,1

MT Zoccolo metallico H 26.1 - Carter di copertura incluso
Metal plinth H 26.1 - Cover carter included

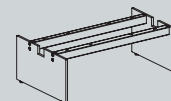

LP/TL 120	L/W 80	P/D 48	H/H 26,1
LP/TL 180	L/W 140	P/D 48	H/H 26,1
LP/TL 240	L/W 200	P/D 48	H/H 26,1

MT Base in metallo - per DV821-Knot
Metal base - for DV821-Knot

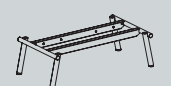

LP/TL 120	L/W 83	P/D 47	H/H 26
LP/TL 180	L/W 143	P/D 47	H/H 26
LP/TL 240	L/W 203	P/D 47	H/H 26

Modulo pensile L 60
Wall unit module W 60

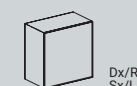
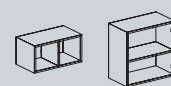

a giorno
open

con anta
with door

L/W 60	P/D 34	H/H 30	a giorno open
L/W 60	P/D 36	H/H 60	con anta with door

Modulo pensile L 120
Wall unit module W 120

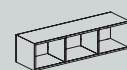

a giorno
open

L/W 120	P/D 34	H/H 30
---------	--------	--------

Modulo pensile L 30
Wall unit module W 30

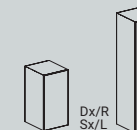
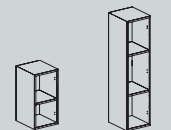

a giorno
open

con anta
with door

L/W 30	P/D 34	H/H 60	a giorno open
L/W 30	P/D 36	H/H 60	con anta with door
		120	

MT Barra per pensili e accessori
Barra per pensili e accessori

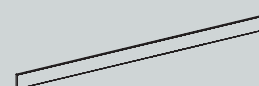

L/W 180	P/D 3	H/H 11
240	3	11

M Melaminico
Melamine

MT Metallo
Metal

Dimensioni espresse in centimetri
Dimensions stated in centimetres

Specifiche Tecniche Technical Sheets

Wire Management	VIGO DV913	p. 198
	NOTO DV911	p. 199
	PLANETA DV902	p. 199
	RYM DV905	p. 200
	VERTIGO DV901	p. 201
	DAKAR DV914	p. 202
	OXFORD DV910	p. 203

Plug&Play DV300		p. 204
--------------------	--	--------

VIGO
DV913

Scrivania
Desk

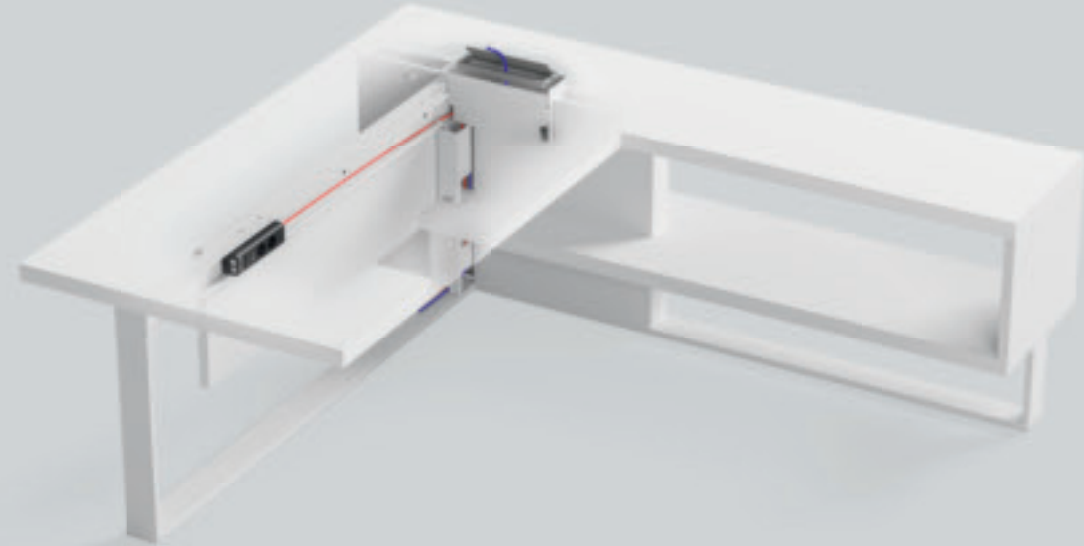

NOTO
DV911

Scrivania
Desk

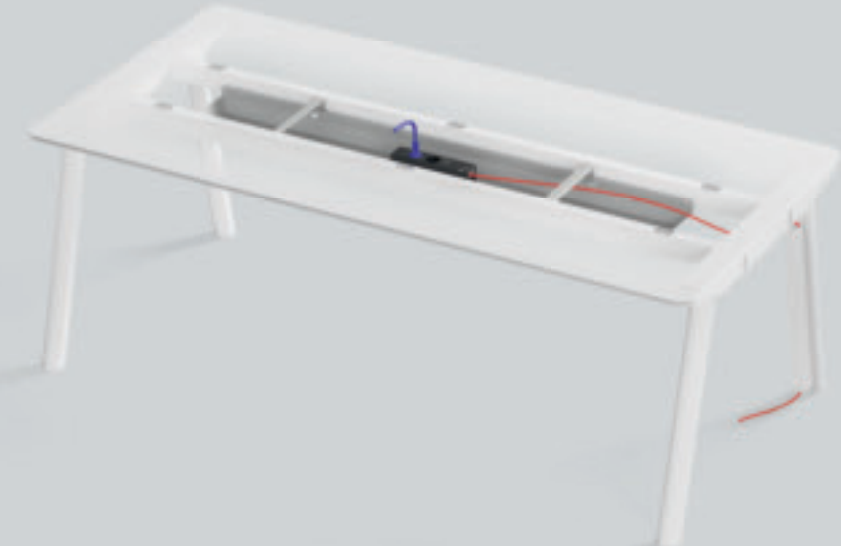

Tavolo riunioni
Meeting table

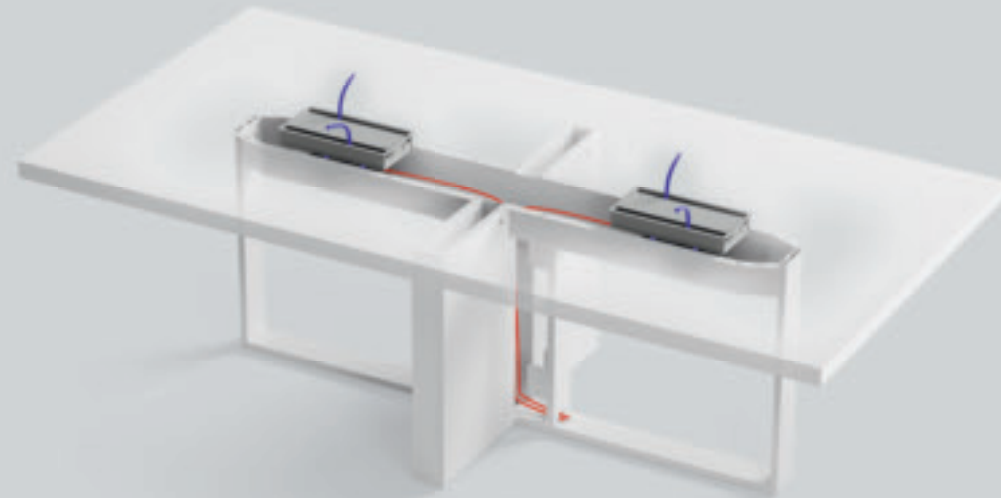

PLANETA
DV902

Scrivania con mobile di servizio
Desk with service unit

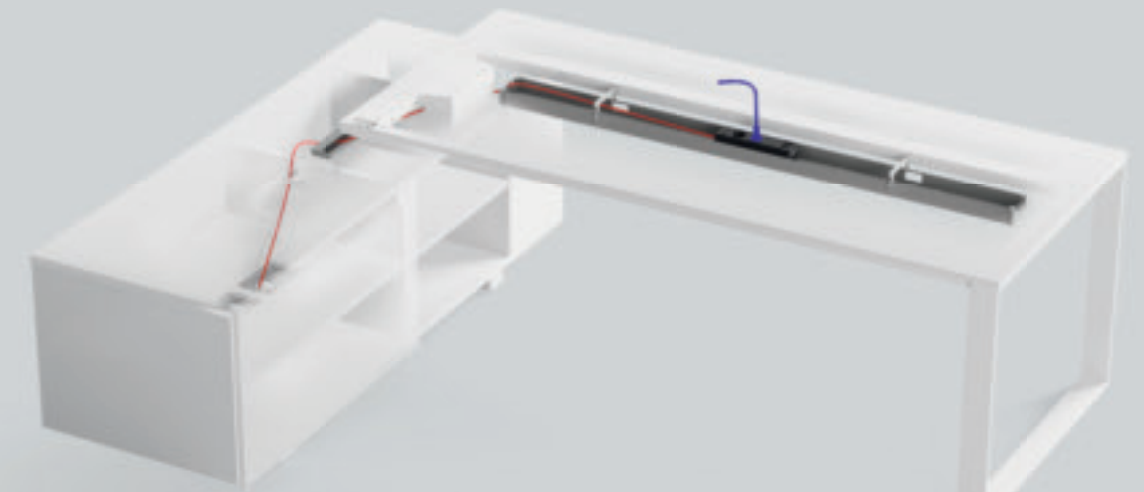

RYM
DV905

Scrivania
Desk

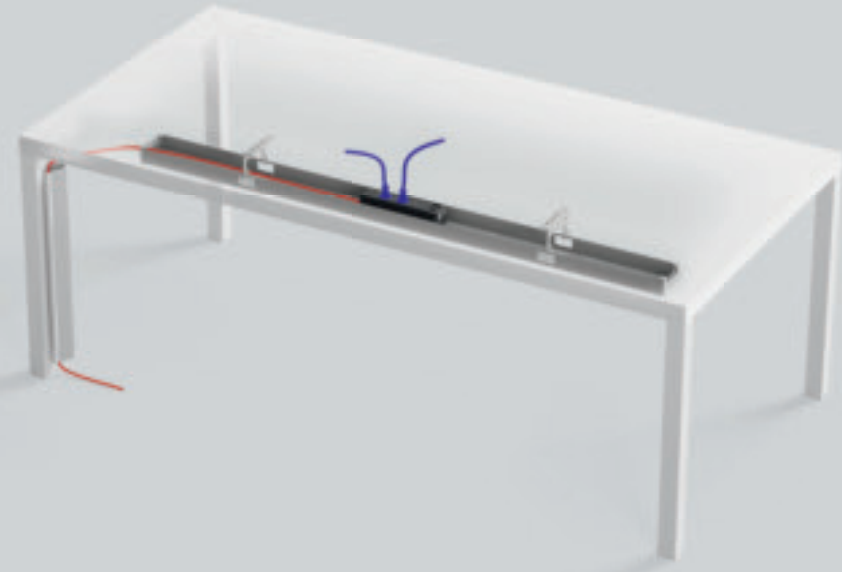

VERTIGO
DV901

Scrivania
Desk

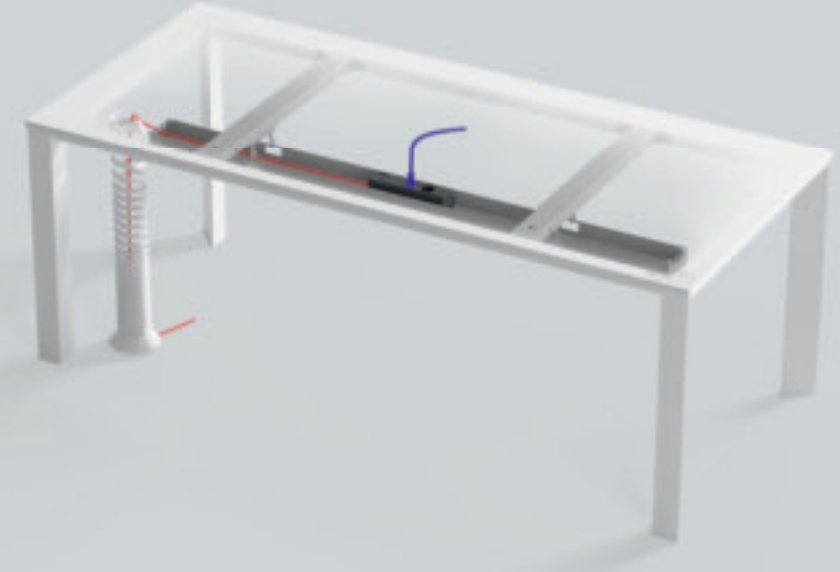

Scrivania con mobile di servizio
Desk with service unit

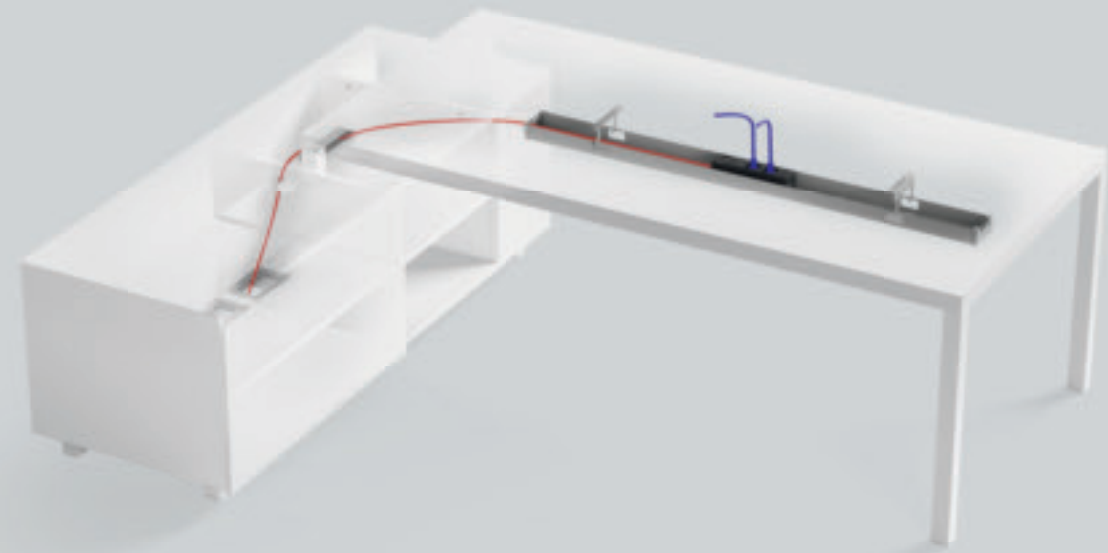

Tavolo riunioni
Meeting table

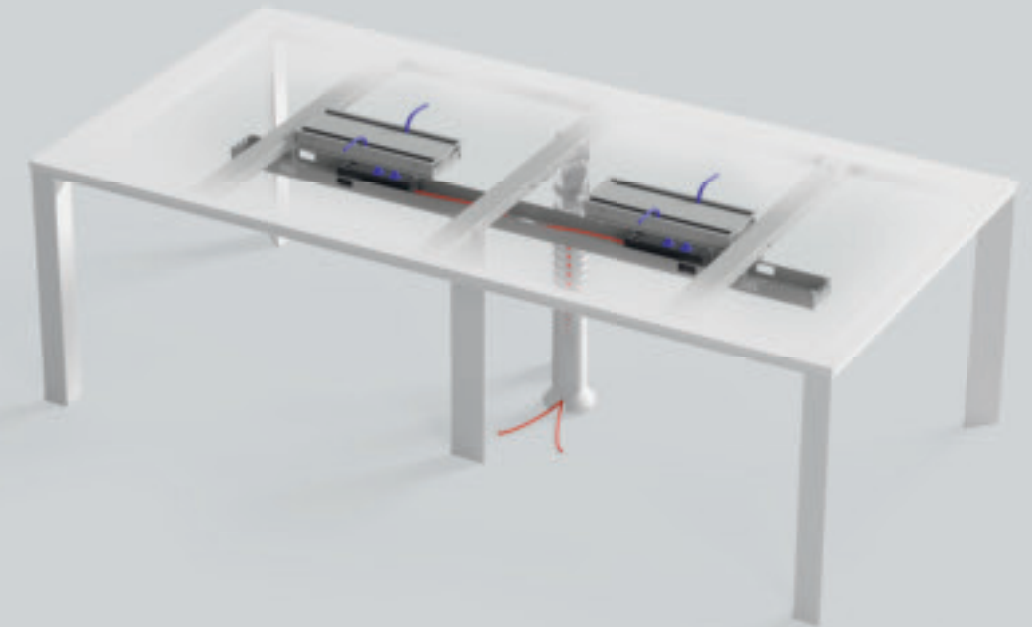

DAKAR
DV914

Scrivania
Desk

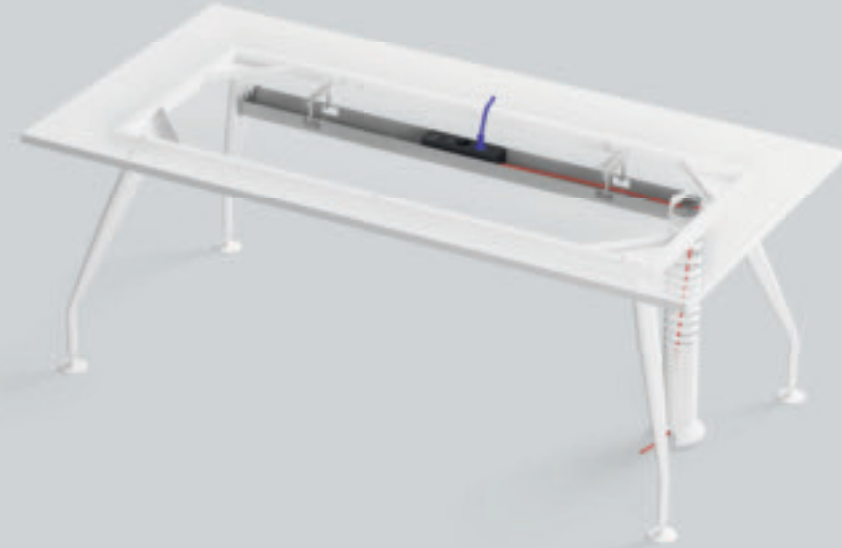

Scrivania con mobile di servizio
Desk with service unit

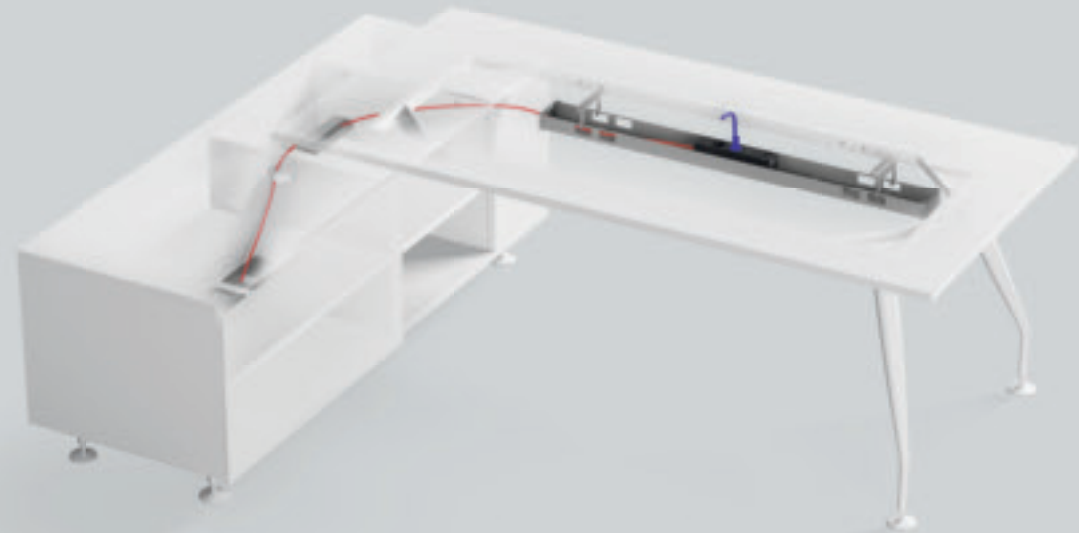

OXFORD
DV910

Scrivania / Scrivania con mobile di servizio
Desk / Desk with service unit

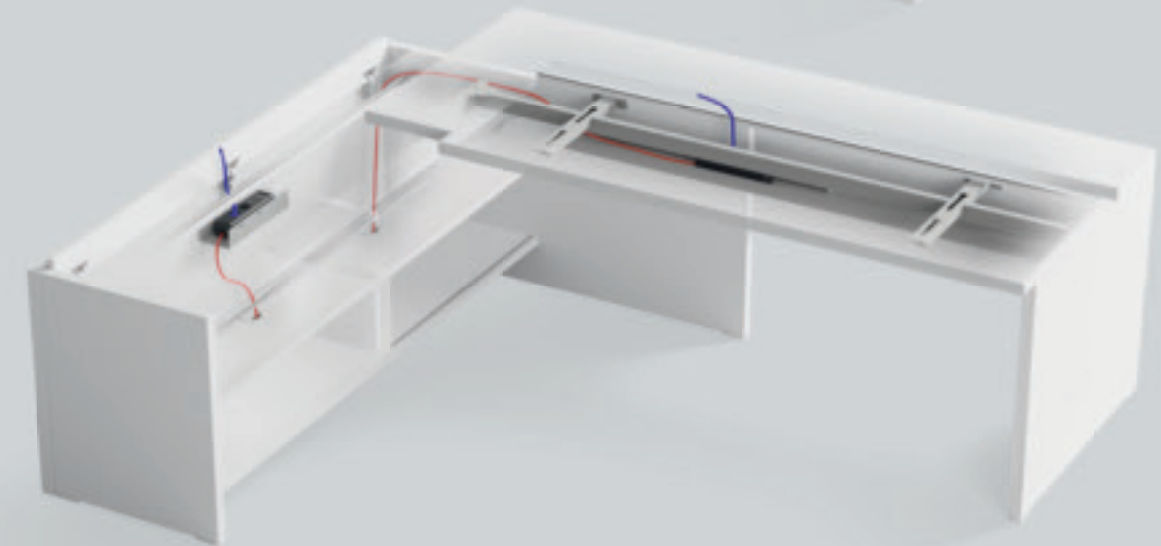
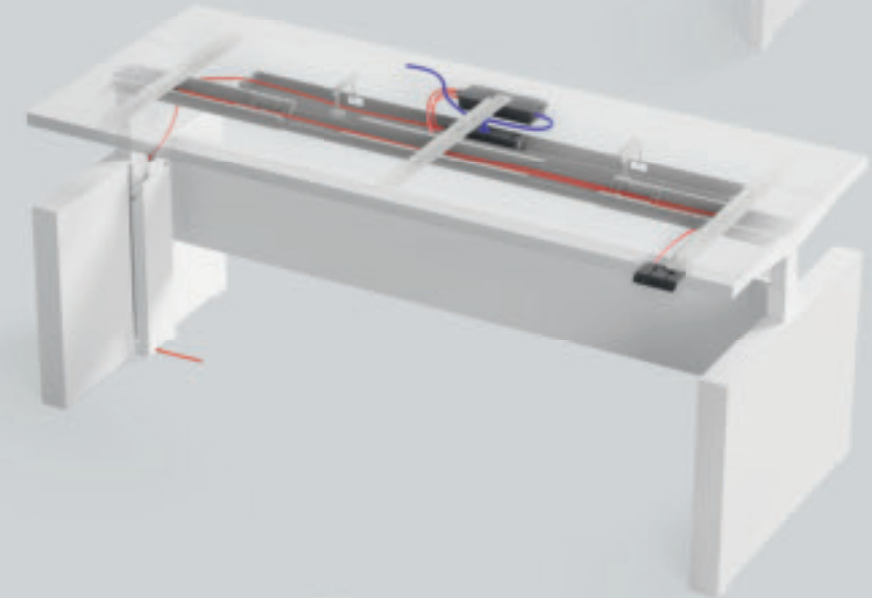
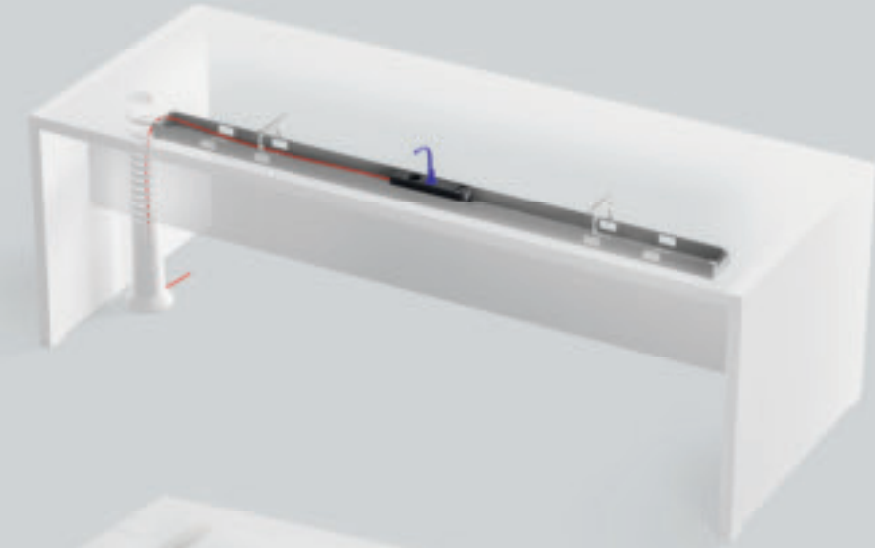

Passacavi bicolore in ABS - Ø 8
2 coloured outlet lid - Ø 8

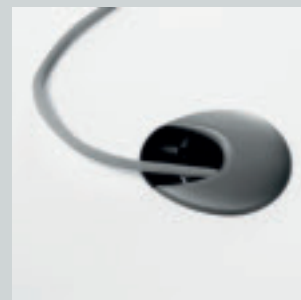

Passacavi in ABS - Ø 6 - 8
ABS outlet lid - Ø 6 - 8

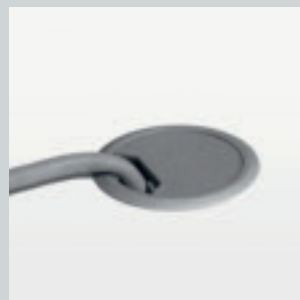

Passacavi in zama - Ø 8
Zamak outlet lid - Ø 8



Tappo elettrificato - Ø 8
Electrified grommet - Ø 8



Top access
Top access

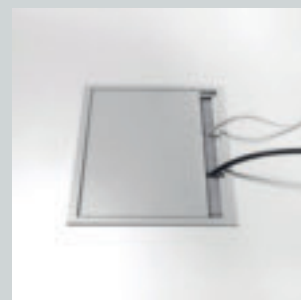

L/W 24 | P/D 10 | H/H 1.5
L/W 32 | P/D 12.3 | H/H 2.4
L/W 32 | P/D 12.3 | H/H 3

Top access elettrificato per scrivania
Electrified top access for desk



L/W 26.3 | P/D 14.8 | H/H 2.5

Top access elettrificato per scrivania
Electrified top access for desk

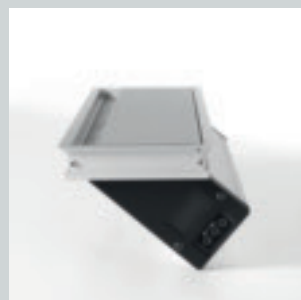

L/W 26.3 | P/D 14.8 | H/H 2.5

Top access per tavoli riunioni
Top access for meeting tables

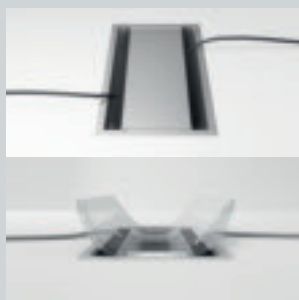

L/W 24.7 | P/D 17.5 | H/H 5
L/W 34.7 | P/D 17.5 | H/H 5
L/W 44.7 | P/D 17.5 | H/H 5

Multipresa elettrificata
Electrified multiple socket



L/W 23.8 | P/D 8.8 | H/H 7.8

Multipresa elettrificata
Electrified multiple socket



L/W 23.2 | P/D 6.2 | H/H 5.1

Multipresa elettrificata
Electrified multiple socket



L/W 12 | P/D 7 | H/H 6.6

Presca USB
USB socket



LEGENDA
LEGEND

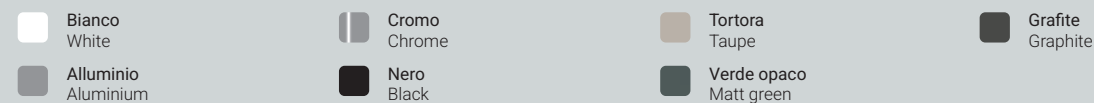

Immagini puramente indicative. Consultare il Listino Prezzi.
Purely indicative images. See Price List.

Porta CPU con cinghie nere
CPU holder with black belts



Porta CPU su ruote
CPU holder on castors



Braccio porta video
statico su palo
Static arm for video
support on deskbase



Doppio braccio porta video
statico su palo
2 static arms for video
support on pole



TIPOLOGIA DI FISSAGGIO
FIXING TYPOLOGY

Fissaggio su piano singolo
Fixing on single worktop



Fissaggio su binario centrale
Fixing on central rail



2 x 3.0 USB Port 0.5A (Type A)



LEGENDA
LEGEND

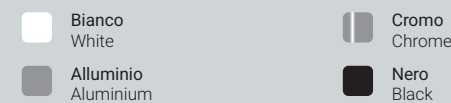

Immagini puramente indicative. Consultare il Listino Prezzi.
Purely indicative images. See Price List.

Passacavi verticale a spirale
Vertical spiral cable duct

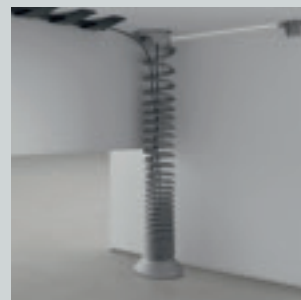

Canalina verticale con zip
Vertical channel with zip

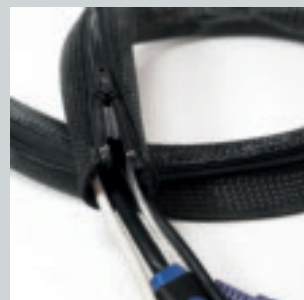

Canale passacavi attrezzabile
Equippable wire management

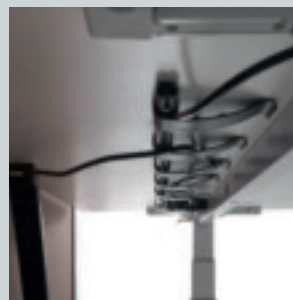

La natura è il motore che sostiene il mondo in cui viviamo. Lavorare in un'ottica green è un impegno e un dovere per avere i piedi radicati a terra nel presente, ma lo sguardo sempre rivolto al futuro.

Per il benessere del domani è indispensabile fare oggi delle scelte sostenibili. Selezioniamo con grande attenzione la qualità dei materiali dei nostri prodotti e soddisfiamo gli standard più rigorosi: prodotti durevoli e sostenibili. Una costante ricerca per un miglioramento continuo nei processi produttivi di ogni nostra attività: essere green è la nostra natura, non solo parole.

Ecco i fatti: le nostre certificazioni aziendali e di prodotto, sono in costante aggiornamento, poiché essere green vuol dire soprattutto sapersi sempre rinnovare per crescere.

Nature is the engine that sustains the world we live in. Working in a green perspective is a commitment and a duty to have one's feet firmly rooted in the present, but one's gaze always turned towards the future.

For the well-being of tomorrow, it is essential to make sustainable choices today. We carefully select the quality of the materials in our products and meet the strictest standards: durable and sustainable products. Constant research for continuous improvement in the production processes of all our activities: being green is our nature, not just words.

Here are the facts: our company and product certifications are constantly being updated, because being green means above all always knowing how to renew in order to grow.

Scopri le nostre certificazioni:
Discover our certifications:



**Concept /
Layout**
Nudesign S.r.l.

**Set design /
Rendering /
Post production /
Color separation**
Nudesign S.r.l.

Print
Grafiche Antiga S.p.A.

Issue 01
February 2025

Special thanks to
Busnelli
Rotaliana
Sitland

dvo_

Foto e testi copyright
We Do Spaces
non riproducibili.
La venditrice si riserva
la facoltà di apportare
al prodotto eventuali
modifiche tecniche,
dimensionali ed estetiche
in qualsiasi momento
senza preavviso.

Pictures and text are
We Do Spaces copyright,
duplicate forbidden.
The selling Company
reserves the right to
introduce changes
to products regarding
sizes and aesthetical
or technical aspects at
any timewithout notice.

We Do Spaces S.r.l.

Via XX Settembre, 272
33080 Roveredo in Piano
Pordenone / Italy

Tel. +39 0434 386 111
www.dvo.it
info@dvo.it



Soggetta ad attività
di direzione e coordinamento
di We.Do Holding S.p.A.



CATEXEC2025

dvo.it